

- 1 Eight-digit liquid crystal time-display in hours, minutes, seconds and hundredths of seconds. While time is running, the hundredths of seconds are not displayed.
- 2 Light emitting diode (LED) signals that the Timer S4 is supplied with 9,5 Volt. If the timer is driven by rechargeable batteries the LED is lighted when batteries are loaded.
- 3 Meter for monitoring power supply, adjustment of photocell form parcours A, B, C, and conductive condition of the start-to-finishing cable form parcours A.
- 4 Knurled screws for loosening and fixing the handle.
- 5 Toggle-switch to select clock A, B, or C. Additional functions as indicated in the instruction manual.
- 6 Start/Stop key with additional functions as indicated in instruction manual.
- 7 Recall (next) button for stored times with additional functions as indicated in instruction manual.
- 6 +7By simultaneously pushing keys 6+7 the display as well as the preselected timer are set at zero (only net times). As long as both keys are pressed down, the display will show only number eights to allow checking of all the display's segments.
- 8 Selector toggle-switch for choosing the programs, testing the lines, and setting the options adjustments
Program selection: press toggle-switch upwards and turn device with switch (17) on
Line test: when pressing the toggle-switch upwards it shows the condition of line on meter (6) (see page 15)
Set up of options: when pressing toggle-switch down it you can adjust the options with the red and yellow key (6+7) (see page 16)
- 9 Connection for headset Q34 (see page 55)
- 10 DIN outlet mainly used to connect the finish photocell of timer A (inputs for K0, K1, and K2). Connection of power supply (NLG4) is also possible (see page 55).
- 11 DIN outlet mainly used to connect the finish photocell of timer B (inputs for K3, K4, and K5). Connection of power supply (NLG4) is also possible (see page 55).
- 12 DIN outlet mainly used to connect the finish photocell of timer C (inputs for K6, K7, and K8). Connection of power supply (NLG4) is also possible (see page 55).
- 13 DIN outlet manly to connect the power supply NLG4, identical with DIN outlet 10 (see page 55).
- 14 Connection for ALGE display board GAZc (see page 56).
- 15 Connection for computer (serial RS 232c interface) (see page 56).
- 16 Connection for Printer P4 (see page 56).
- 17 On/Off switch
- 18 Banana outlet (red and black) for channel 9
- 19 Banana outlet (green and black) for channel 0
- 20 Banana outlet (green and black) for channel 3
- 21 Banana outlet (green and black) for channel 6
- 22 25-pin D-Sub-Miniature outlet with all 18 channels (see page 56).
- 23 Indicates the internal setting:
 red = rechargeable batteries
 black = alkaline batteries
- 24 Outlet for countdown loud speaker (e.g. for show jumping, swimming,...)

Table of contents

1.	DESCRIPTION OF DEVICE	3
1.1.	Standard Programs	3
2.	OPERATING	5
2.1.	Power Supply	5
2.2.	How to connect other devices with the Timer S4	8
2.3.	Memory	12
2.4.	Control Function	13
2.5.	Line Test - Checking of the Start - Finish Line	14
2.6.	Set up of Options	15
2.6.1.	Set delay time	16
2.6.2.	Duration of displaying time on display (1) and on a display board	17
2.6.3.	Split, Sequential or Time-out	17
2.6.4.	Running tenth on or off	18
2.6.5.	Set up of display board interface (14)	18
2.6.6.	Precision	19
2.6.7.	Display automatic	19
2.6.8.	Adjust Printer options	20
2.6.9.	Photocell distance for speed measurement	20
2.6.10.	Adjustments for swimming	20
2.7.	Timing impulse beep	21
2.8.	Synchronize start	21
3.	TIMING	22
3.1.	Show Jumping (Program 2)	23
3.1.1.	Standard Show Jumping (Bareme A)	24
3.1.2.	Standard Show Jumping in two stages	28
3.1.3.	Standard Show Jumping with Stage (Bareme B)	29
3.1.4.	Show Jumping with Time Penalty (Bareme C)	30
3.1.5.	Two Stage Show Jumping (Bareme A Barrage Integre)	33
3.1.6.	Standard Show Jumping with American Jump Off - E	37
3.1.7.	Standard Show Jumping with American Jump Off - F	41
3.1.8.	Carriage Driving	44
3.1.9.	Standard Show Jumping combined with Show Jumping with Time Penalty	45
3.1.10.	Dog - Agility	49
3.1.11.	Dog - Agility Gambler	51
4.	DEVICES USED WITH THE TIMER S4	53
4.1.	Printer P4	53
5.	TECHNICAL DATA	55
5.1.	Connection System	56
5.1.1.	Photocell jacks and external supply	56
5.1.2.	Headset Jack Q34 (9)	56
5.1.3.	Loud Speaker Jack (24)	56
5.1.4.	Display Board Jack (14)	57
5.1.5.	Printer Jack (16)	57
5.1.6.	RS 232c - Computer Jack (15))	57
5.1.7.	Multi Channel Outlet (22)	57
5.2.	Computer connection - RS 232c interface (15)	58
5.3.	Connection for the display board	63
5.4.	Connection for Printer P4 (16)	63

1. DESCRIPTION OF DEVICE

The Timer S4 is the descendent of the popular S3 Timer used for over 10 years worldwide. S3 users upgrading to the S4 will find the Program "0" to be familiar with the older Split Program. We recommend that you start your use of the S4 with Program "0" first as a tutorial.

The Timer S4 is equipped with the most modern CMOS microelectronics. Universal software allows the timer to be used for a variety of applications. Many aspects of the software have crossover applications for other sports as well. All previously manufactured ALGE sensors and accessories will work to 100% effectiveness.

- Temperature compensated quartzoscillator (TCXO), for the highest timing precision possible.
- 18 timing channels
- You can store up to 8000 times in the memory. Every timing impulse is automatically stored with a continuous ID number.
- Storage of memory even when device is turned off
- Battery box located in the bottom of the case for security against leakage.
- Battery powered by either "C" cell alkaline or NiCads.
- Communication on six channels is possible.
- Connections for the following devices are available:
 - o ALGE Printer P4
 - o ALGE display board GAZc
 - o ALGE photocell RLS1c, RLS1cd, or RLS3c
 - o ALGE startgate STSc
 - o ALGE headset Q34
 - o RS 232c interface to connect a computer

Press red and yellow button (6+7) at the same time:

When described in the text: press red and yellow button (6+7) at the same time you have to do the following:

- press yellow button (7) and continue holding it down
- press red button (6)
- release red and yellow button (6+7)

1.1. Standard Programs

Program	Program Number
Split or Sequential	Prog. 0
3-Course-Timer	Prog. 1
Show Jumping	Prog. 2
18-Channel-Timer	Prog. 3
Parallel Slalom	Prog. 4
Speed	Prog. 5
Swimming	Prog. 6
Automatic	Prog. 7
Seconds Mode	Prog. 8

SPLIT or SEQUENTIAL**Prog. 0****see Timer S4 manual**

Net-timing for events with single start. It is possible to have three competitors at the same time on the slope. Any number of intermediate times are possible.

3-Course-Timer**Prog. 1****see Timer S4 manual**

Net-timing for events with three race tracks (three separate start and finish).

Show Jumping**Prog. 2****see page 24**

We have a special manual for show jumping. Please ask your ALGE-dealer for this manual.

18-Channel-Timer (Time of Day Printer) Prog. 3**see Timer S4 manual**

Timer with one start channel and 17 separate stop channels. It is also possible to time with a time of day and net-time

Parallel Slalom**Prog. 4****see Timer S4 manual**

Timing for parallel slalom or pursuit. There is a program, that measures only the finish difference time, and one measuring the net time of both competitors as well as the finish difference time.

Speed**Prog. 5****see Timer S4 manual**

Speed measurement between to points (one direction). Measurement distance is adjustable from 1 to 180 m. The measurement is in km/h, m/s or mph.

Swimming**Prog. 6****see Timer S4 manual**

Timing for swimming. If you use this program together with the touch pad TP1 and the start acoustic SA1, then you need the separate manual for swimming.

Automatic**Prog. 7****see Timer S4 manual**

Net-timing program that runs the Timer S3 automatic (no operator is necessary). You can input the amount of impulses per competitor. As soon as a competitor receives all impulses, it resets the clock and the next is able to start.

Second Mode**Prog. 7****see Timer S4 manual**

Net-timing for events with single start. It is possible to have three competitors at the same time on the slope. Any number of intermediate times are possible. After 60 seconds it does not count with minutes, but continues with 61, 62, etc.

2. OPERATING

2.1. Power Supply

- Input of 6 alkaline "C" cell batteries with 1,5 Volt or 6 NiCad-"C" cell rechargeable batteries with 1,2 Volt (see picture below or in the battery case) .

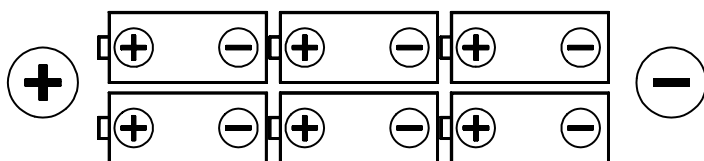

Attention: Take the alkaline batteries out of the Timer S4 at the end of a season. A leaking battery could destroy the device!

Please respect the environment. Return your batteries to a recycling station or dispose of them in another proper manner.

- Battery test: turn Timer S4 on. If the needle of the meter (3) is in the green field you have enough power.

Attention: When using the ALGE Printer P4 you must use the NiCad rechargeable batteries.

You have the following possibilities of power supply:

- o 6 Alkaline "C"-cell-batteries with 1,5 Volt
- o 6 NiCad "C"-cell-batteries with 1,2 Volt.
Charging time: about 14 hours

Attention: If you input NiCad batteries yourself (e.g. if you buy at a later point the Printer P4), please contact your ALGE dealer. He will tell you how to activate the internal charging circuit.

- o If you have AC power you can supply the Timer S4 with the power supply NLG4 direct. The batteries will function as a back up in case of power failure.

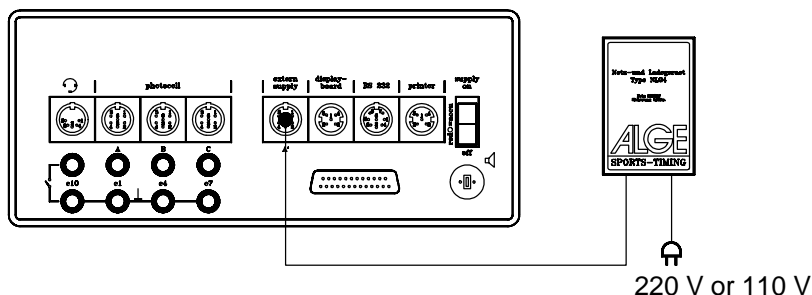

- o NiCad batteries should be checked individually with a voltmeter every 6 months to determine if they are holding a charge properly. Replace any individual battery that drops below the 1.2 volt level.
NiCad batteries have a useful service life of 4-5 years.
- o Replace your Alkaline batteries prior to an important meet. It is inexpensive insurance against failure. Use the older batteries up in your flashlight or put them in the kids toys (they won't know the difference).
- o Connection to an external battery (12 V, about 5 Ah): we deliver on request the correct battery cable (005-02). The internal batteries are used to back up.

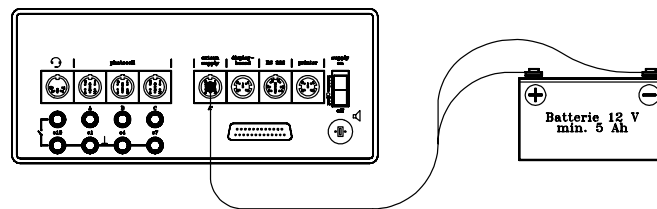

Adjustment of the Timer S4 for rechargeable- or alkaline batteries:

On the backside of the Timer S4 is a hole (23), which indicates if the S4 is set up for alkaline or rechargeable batteries.

- hole (23) is red, which means it is set up for rechargeable batteries
- hole (23) is black (dark), which means it is set up for alkaline batteries

Charging condition of batteries:

You can check the condition of the batteries by pressing toggle switch (8) upwards (position program/line test). It shows now in the display (1) the program number, baud rate of interface "display board", "printer" and "RS 232", as well as the voltage of the batteries.

Use the following table only as approximate value. The batteries from different companies have different characteristics as well as the temperature changes the battery condition.

Battery Condition	Alkaline Battery	NiCd Rechargeables	Needle of Meter
Full	about 8,7 Volt	about 7,2 Volt	green/black
3/4 full	about 8,1 Volt	about 6,9 Volt	green
1/2 full	about 7,5 Volt	about 6,9 Volt	green
2/4 full	about 6,9 Volt	about 6,9 Volt	green
empty	about 6 Volt	about 6 Volt	green/red

Approximate duration of NiCads- and alkaline batteries:

	<i>NiCd-rechargeables</i>	<i>Alkaline batteries</i>
S4 with one RLS1c, without printer	28 hours	112 hours
S4 with three RLS1c or one RLS3c without printer	16 hours	64 hours
S4 with one RLS1c, with Printer P4 (every 30 seconds one print)	24 hours	96 hours
S4 with three RLS1c or one RLS3c with Printer P4 (every 30 seconds one print)	12 hours	48 hours

At temperatures of -20°C is the duration of a battery about 20% less.

The measurement was done with ALGE photocells RLS1c and the ALGE Printer P4 at a temperature of 20°C.

When using an ALGE Printer P3 it has about the half duration time written in the last two lines in the above table.

2.2. How to connect other devices with the Timer S4

Complete installation with radio transmission for start and finish impulses. Two display boards are used for public information, which show time and points. A printer prints all important data of the event (times, points, time-out, penalty seconds, etc.). A horn signals the countdown and time-out.

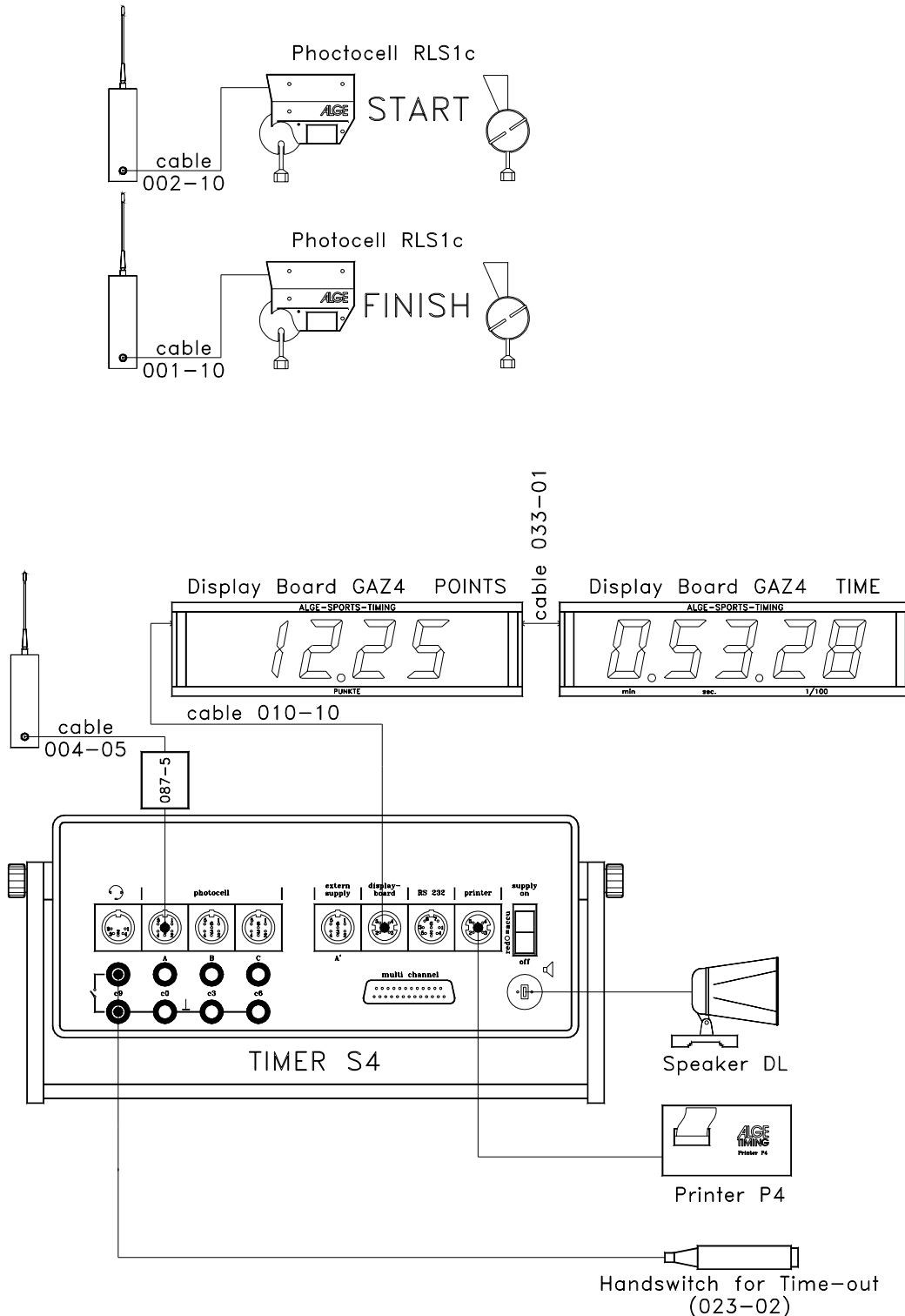

o Telesignal and Photocells for Start and Finish:

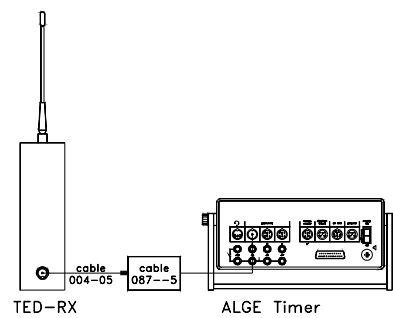
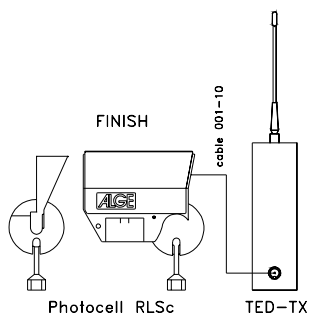
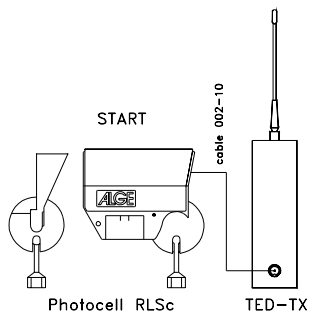

o Telesignal and Photocell used for Start and Finish at the same time:

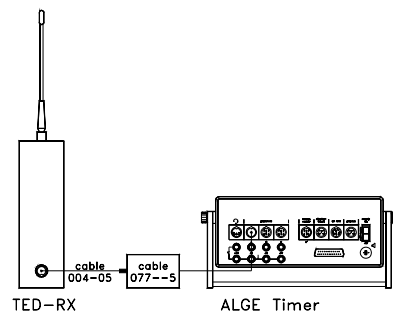
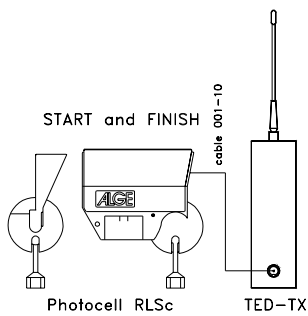

o Handswitch for Time-out:

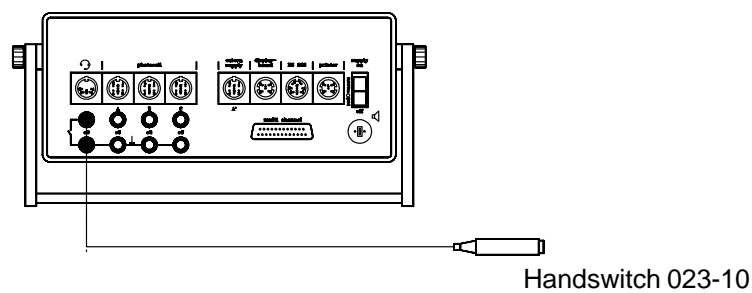

- o Photocell for the Start (without radio transmission):

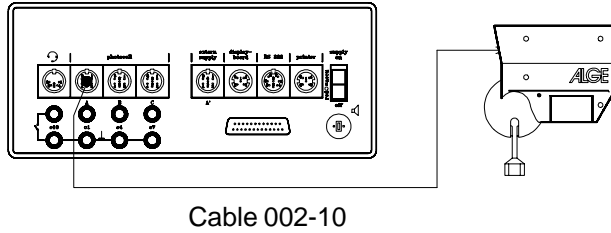

- o Photocell for the Finish (without radio transmission):

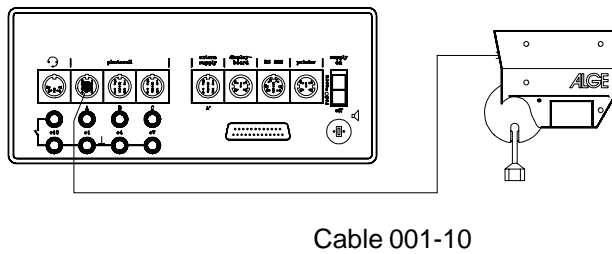

- o Printer P4:

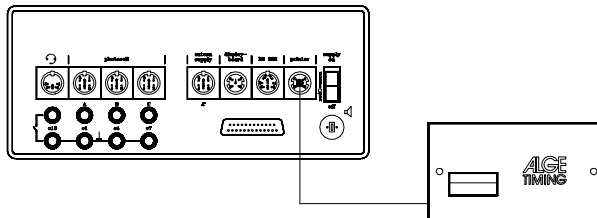

- o Speaker DL for acoustic countdown:

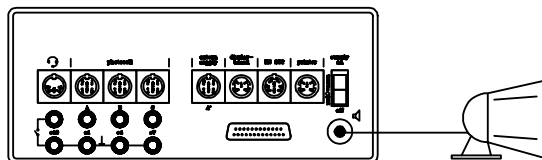

o Display Board GAZc with Cable 010-10:

for distances of more than 10 m use ALGE cable reel KT300

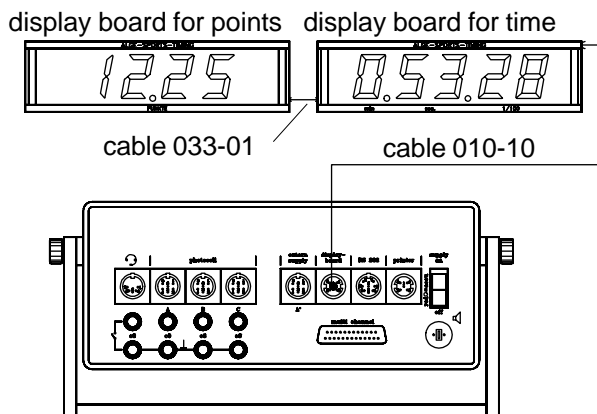

One display board has a built in powerpack (or has an external supply), the second board is supplied by from the first board when using cable 033-01. The data cable 010-10 from Timer S4 is plugged at the yellow/black banana socket at one board.

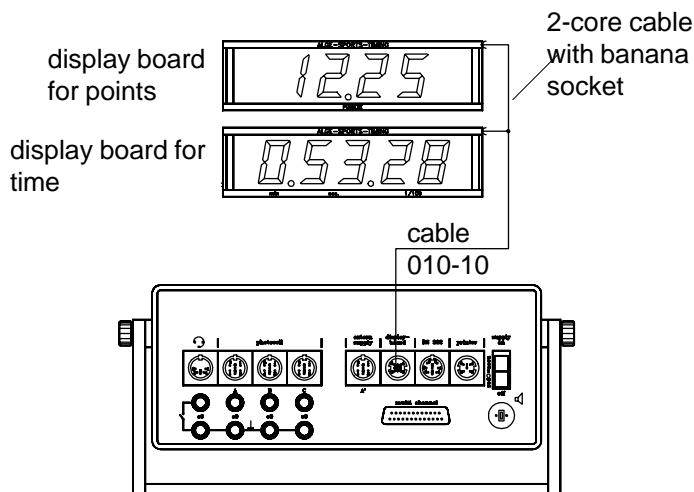

Both display boards have a built in powerpack (or have an external supply). Plug the data cable 010-10 coming for the Timer S4 at any board and connect the second board with a cable (two wires) that has at both ends banana plugs.

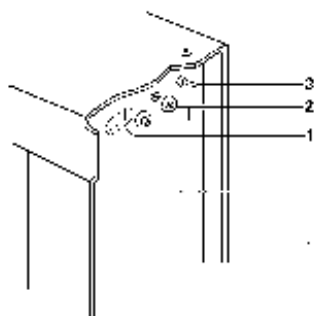

Time Display Board:

- 1 thumb wheel switch on position 0
- 2 banana socket to connect cable 010-10
- 3 shift switch on middle position

Point Display Board:

- 1 thumb wheel switch on position 0
- 2 banana socket to connect cable 010-10
- 3 shift switch on upper position

2.3. Memory

This feature is designed to allow users of the S4 with a computer interface to access times stored in memory. You must use a computer to take advantage of this feature. The default setup from the factory has the S4 automatically recording all times up to 8000. When turning the device on it shows you on the display how much memory is occupied:

- FULL: 0.0 memory is empty, free memory capacity is about 8000 times
- FULL: 0.5 memory is 50% full, free memory capacity is about 4000 times
- FULL: 1.0 memory is full, you need to clear the memory

The memory can store up to 8000 times with a continuous ID number assigned to each time (see data format of each program). During operation you can control the free memory space with the control function (see next page). If you plan to download data from the memory clear the S4 prior to the competition.

Clear Memory:

There are two ways to clear the memory:

- o from the RS 232 interface:
 - A hexadecimal code is transferred from a computer through the RS 232 interface (see chapter 5.2.).
- o when turning the S4 on:
 - press toggle switch (8) to upper position
 - turn device on (switch 17)
 - release toggle switch (8)
 - select program with the yellow key (7)
 - press toggle switch (8) to upper position
 - display (1) shows "CLr nEln" (= clears memory not)
 - press yellow button (7)
 - display (1) shows "CLr JA" (= clears memory)
 - press red and yellow button (6+7) at together
 - memory will be cleared each time you turn the device on, as long as you do not switch back to "CLr nEln".

During the timing mode you can check the adjustment for the memory by pressing the toggle switch (8) to the upper position (see page 14, chapter 2.6.).

Transmission of the memory:

You can transmit the memory at any time during the operation of the Timer S4. The transmit order must be given by the computer through the RS 232 interface. The Timer S4 starts to transmit as soon as it receives the hexadecimal code 85 (see page 59, "Memory output").

Memory output in blocks:

It is possible to output a block of data from the memory (RAM) of the Timer S4 using the RS 232 interface (15). You have to input the hexadecimal code 84, the first address and the last address in ASCII.

e.g.: 84(Hex)09341330 = output of all data from memory number 934 to 1330 through the RS 232 interface

2.4. Control Function

As soon as the Timer S4 is in timing function you can control some of the adjustments on the display.

- press toggle switch (8) to the upper position
- on the display (1) it shows in the following order:
 - o program number and version
 - o occupied memory space
 - o if it clears the memory when turning the device on
 - o baud rate of interface 1: display board (14)
 - o baud rate of interface 2: printer (16)
 - o baud rate of interface 3: RS 232 (15)

Program number and version:

e.g.: Pr.1 V92.E = program number 1, Version 92 E

Occupied memory space:

FULL: 0.0 memory is empty, free memory capacity is about 8000 times
FULL: 0.5 memory is 50% full, free memory capacity is about 4000 times
FULL: 1.0 memory is full, you need to clear the memory

If it Clears the memory when turning the device on:

CLR. JA it clears the memory when turning the device on
CLR. nEln it does not clear the memory

Baud rate of interface 1: display board (14)

pre adjustment: 2400 baud
possible adjustments: 19200, 9600, 4800, 2400 Baud
adjustment: see page 60

Baud rate of interface 2: printer (16)

pre adjustment: 2400 baud
possible adjustments: 19200, 9600, 4800, 2400 Baud
adjustment: see page 61

Baud rate of interface 3: RS 232 (15)

pre adjustment: 4800 baud
possible adjustments: 9600, 4800, 2400, 1200 Baud
adjustment: see page 59

2.5. Line Test - Checking of the Start - Finish Line

Checking of the 1 pair cable which is connected at banana socket A (19). Turn the Timer S4 on (switch 17) and choose any program:

o Short-circuit-Test:

- Cable is open at the start side
- Press toggle switch (8) upwards (direction "line test")
- Needle of meter (3) must stay in the middle of the green area (otherwise short-circuit)

o Resistance-Test:

- Short the pair on the start side (press banana plug together)
- Press toggle switch (8) upwards (direction "line test")
- Needle of meter (3) must go to the far left side (otherwise is the resistance too high; maximum 2000 W loop resistance).

Needle is at 2000 W about 1 mm before the left end.

The line test meter is only for quick reference. Please use a multimeter set on Ohms for accurate testing of your wiring. Remember that resistance on the line will change due to weather conditions. Always check the condition of splices, especially in extremely cold temperatures. Scotchlocks and AMP locks have a bad habit of opening due to the expansion rate differences between the copper wire and the steel splicing plate. You should use the older "White Bean" connectors if there is a chance that temperatures will fall to below -10 F (-15°C).

Most of the problems with timing installations are due to wiring on the course. Please take the time to review your wiring early in the season. Bad splices and connections will only get worse as time goes on and they are a lot easier to deal with in the Fall before the pedestals get covered with snow.

Please call your ALGE agent for assistance with wiring. They are able to consult with you on proper wiring plans and are usually available to travel to your site for more detailed work at reasonable expense.

2.6. Set up of Options

The Timer S4 is a very universal device. In order to have a universal device, it is necessary that the user is able to adjust some features.

The default language used for most of the options is German.

AUS = OFF
EIN = ON
JA = YES
NEIN = NO
LF = RUNNING TIME
CH = CHANNEL
LZE = RUNNING 10ths

If you change options, they will be stored even after turning the device off.

If you want to have to the original default set up of the options, then do the following:

- turn Timer S4 off (switch 17)
- press yellow button (7) down
- press toggle switch (8) upwards (position program+line test)
- turn Timer S4 on (switch 17)
- release yellow button (7) and toggle switch (8)
- choose program with the yellow button (7)

You can set the following options (depending on the program you use):

- **dF** **delay time finish**
 0,00 to 9.9 seconds
- **dS** **delay time start**
 0,0 to 9.9 seconds
- **SLP** **duration of displaying time on display (1) and on a display board**
 only for program *18-Channel-Timer*, 0,0 to 9,9 seconds
- **SE or TO** **split, sequential- or time-out**
 for program SPLIT or SEQUENTIAL you can switch between split or sequential mode;
 for program *18-Channel-Timer* with time of day you can switch channel 9 between sequential and time-out
- **nET** **net time on or off**
 only for program *18-Channel-Timer with time of day* for interface display board (14)
- **LZE** **running tenth on or off**
 AUS = running tenth off
 Ein = running tenth on
- **LF** **running time for display board interface**
 LF-CH1-2 = running time is on channel 1 and 2 on
 LF-CH1 = running time is on channel 1 on

- **TAU** **thousandth on or off**
 AUS = thousandth off
 EIN = thousandth on

- **HUn** **hundredth on or off**
 AUS = hundredth off
 EIN = hundredth on

- **AUT** **display automatic on or off**
 EIN = you can set the display time with variable SLP
 EINL = only the first time will be shown on the display board
 AUS = manual change of display with yellow key (7)

- **Pri** **printer speed (set up 60 for Printer P3)**
 Input range: 0 to 9.9 (0 = off, 0.1= fast, 9.9 = slow)

- **Lr** **line feed for printer**
 Input range: 0 to 9 (amount of line feeds after each line)

- **di.** **photocell distance for speed measurement**
 Input range: 1 to 180 Meter

- **A00** **Amount of touches for swimming**
 Input range: 0 to 99 touches

- **n01** **competition number and running number for swimming**
 Input range: 0 to 99

How to set the options:

- o press toggle switch (8) upwards (program+line test)
- o turn Timer S4 on (switch 17)
- o release toggle switch (8) when display (1) shows 8.8:8.8:8.8.88
- o select program with yellow button (7)
- o press yellow and red button (6+7) together
- o program is ready for timing
- o press toggle switch (8) downwards (delay time)
- o changing of options is now possible
- o increment choices with yellow and red button (6+7) red button is for left of the decimal, yellow for right
- o press toggle switch (8) downwards (delay time) to set the next variable

2.6.1. Set delay time

dF and dS

Alter the delay time to prevent accidental recording of extra impulses. You will need to experiment with this feature somewhat as it will change between sports and the start interval that determines the likelihood of athletes bunching up as they approach the finish.

The delay is designed to prevent the timer from receiving another impulse from the same channel for a definite time after an impulse. You can set the delay time separate for the start channels and finish channels.

- o set the display (1) on 0:00.00 (press red and yellow button (6+7) together)
- o press toggle switch (8) downwards (delay time)

- o it show on the display (1) the finish delay time (dF = delay time finish)
- o increase delay time by 0.1 seconds by pressing the yellow button (7), or 1 second by pressing the red button (6)
- o switch the delay time from 1/10 to 1/100 accuracy by pressing toggle switch (8) to the upper position. Increase delay time by 1/100 seconds by pressing the yellow button (7), or 1/10 seconds by pressing the red button (6)
- o press toggle switch (8) to lower position "delay time"
- o it shows in display (1) the start delay time (dS = delay time Start)
- o increase delay time by 0.1 seconds by pressing yellow button (7), or 1 second by pressing red button (6)
- o when start delay time is set press red and yellow button (6+7) at once
- o the new delay time is now stored and the Timer S4 is ready for timing

Attention: Set the finish delay time for alpine skiing quite long (about 0.7 sec.), because a competitor should not be followed by another within a short time. For cross country skiing you need a shorter finish delay time, because the competitors can cross the line closely after one another. On the other hand if you choose a very short finish delay time it gives you more impulses (e.g. both legs make you an impulse).

EXPERIMENT BEFOREHAND!!!

The S4 will BEEP for the entire time of the delay. This is normal.

2.6.2. Duration of displaying time on display (1) and on a display board

SLP

This can be set only in the program *18-Channel-Timer*, *Speed*, and *Automatic*. You can set the time during which a stopped time is shown on the display board.

- o input range: 0,0 to 9,9 seconds

The "display automatic" must be on (see page 20, chapter 2.6.7.) in order to have a function of SLP.

2.6.3. Split, Sequential or Time-out

SE or TO

Using program 0 "SPLIT or SEQUENTIAL" you can set the split- or sequential mode.

- o SE AUS SPLIT-mode is on
- o SE EIN SEQUENTIAL-mode is on

Using program 3 "18-Channel-Timer with time of day" you can set if channel 9 (red banana socket, 18) is used for sequential timing or time out.

- o SE nod Sequential (lap timing) on channel 9 (banana socket 18)
- o TO nod Timer-out on channel 9 (banana socket 18)

Using program 3 "18-Channel-Timer with time of day and countdown" you need to set the following:

- o SE nodC Count-down with sequential (lap timing) on channel 9 (banana socket 18)
- o TO nodC Countdown with timer-out on channel 9 (banana socket 18)

Set SE nodC or TO nodC by pressing toggle switch (8) to upper position when display shows SE nod or TO nod.

2.6.4. Running tenth on or off

LZE

If you turn the running tenth on then it shows the running tenth on the display (1) and you have an output through the serial interface.

- o LZE Ein = running tenth on
- o LZE AUS= running tenth off
- o With the yellow button (7) you switch the running tenth on or off.

If you insert the time for TV, you should have the running tenth on.

2.6.5. Set up of display board interface (14)

LF, nET

Normally you have the following setup: LF-CH1-2 and SEC AUS

Running time for display board interface: LF

Running time or run time:

Plug the display board into socket (Display Board 14) . You can turn the plug 180° (two different channels, see page 62 chapter 5.3.)

- channel 1: running time
- channel 2: changing between running time or run time is possible
- o LF-CH1-2 = output of running time on channel 1 and 2
- o LF-CH1 = output of running time on channel 1, output of run time on channel 2
- o Press the yellow button (7) to change channel 2

Address for display board GAZc:

Normally the output is without address (thumb wheel switch of display board is on position 0). If you have an output with address you can show on different display boards different times. A address for the output is possible with the following programs:

- 3-Course-Timer
- Parallel slalom with finish-difference time and net time

Activating the address:

- display (1) shows "LF CH1-2"
- press toggle switch (5) to upper position
- display (1) shows "LFACH1-2"

A description of how to setup the display board you can find in the specified program description.

Net time on or off: nET

This function is only active in program 3 "18-Channel-Timer with time of day" and "18-Channel-Timer with Countdown". You can choose the output of the net time through interface "Display Board" (14). If you output the net time and time of day the baud rate changes automatically from 2400 to 4800 baud.

Attention: Be advised that if you choose this option you will have to replace the EPROM in the GAZc display board to 4800 baud.

- o nET AUS output of time of day (display board 14)
- o nET EIN output of time of day and net time (display board 14)

2.6.6. Precision**TAU, HUn**

You can set the precision of the timing. The following set up is possible:

Precision = 1/1000 seconds: TAU EIN

Precision = 1/100 seconds: TAU AUS and HUN EIN

Precision = 1/10 seconds: TAU AUS and HUn AUS

- o switch with yellow button (7) between on = EIN and off = AUS
- o switch with toggle switch (8) from TAU to HUn

1/1000 seconds shown on the display:

The display (1) shows normally 1/100 seconds (exception is the Parallel Slalom program). If you need to show the 1/1000 seconds on the display do the following:

- display (1) shows "TAU EIn"
- press toggle switch (5) to upper position
- display (1) shows "TAU EInL"

If you switch the 1/1000 seconds in the display (1) on it will not show the hours.

2.6.7. Display automatic**AUT**

You can adjust the display time of display (1) and the display board manual or automatic. If the automatic is on (AUT EIn) it will show the time as long as "SLP" (see page 18 chapter 2.6.2.) is adjusted.

If the automatic is turned off (AUT AUS) "SLP" has no function.

- o AUT EIn automatic display is on
- o AUT EInL display shows always the first time (e.g. for track and field)
change to actual time by pressing the yellow button (7)
- o AUT AUS automatic display is off

- o change from on (EIn) to off (AUS) by pressing the yellow button (7)
- o Press toggle switch (8) to upper position to change from "AUT EIn" to "AUT EINL"

2.6.8. Adjust Printer options**Pri, Lr**

You can adjust the following options for the printer:

- Printer speed Pri
- Line Feed Lr

Printer Speed Pri:

Speed for sending data strings to the printer.
Input range from 0 to 9.9

- o increase printing speed by 0.1 by pressing yellow button (7)
- o increase printing speed by 1 by pressing red button (6)

- 0 printer off
- 0.1 very fast data strings to the printer (buffer is necessary, Printer P4)
- 6.0 data strings are sent every second (Printer P3)
- 9.9 for very slow printers

Printer P4: best adjustment is 0,1
Printer P3: best adjustment is 6.0

Carriage Return for Printer Lr:

You can adjust the amount of Carriage Return from 0 (prints into each line) and 9 (after each printed line are 9 empty lines).

- o increase the line feed by pressing the yellow button (7)

- o Experiment to find the best number of returns. You will want the times to be forwarded a couple of lines above the cutter, but not as much as to waste paper.

2.6.9. Photocell distance for speed measurement**di**

You have to input the photocell distance for speed measurement (program 5). The distance is adjustable from 1 to 180 m.

- o increase by 10 Meter increments by pressing the red button (6)
- o increase by 1 Meter increments by pressing the yellow button (7)

2.6.10. Adjustments for swimming

You have to input the following for the swim-program (program 6):

- o amount of touches per line (from 1 to 99) A
- o competition number (from 1 to 99) n
- o running number (from 1 to 99) n
- o finish-delay time (from 10 to 99 seconds) dF

2.7. Timing impulse beep

The Timer S4 makes a beep for every timing impulse. The duration of the beep is equivalent to the adjusted delay time.

You can switch the tone of the beep on or off by pressing the toggle switch (8) to the upper position when receiving a stop impulse.

2.8. Synchronize start

A synchronized start is a feature which allows a start impulse from the S4 to transmit through all start channels to start other timers. A synchronized start is necessary to start different timing devices at the same time in order to meet the timing regulation of the FIS and other federations.

Making a synchronize start:

all programs except 18-Channel-Timer with time of day)

- connect all timers with synchronize cable 004, or banana plug jumper coming out of channel "A" (19) to the banana plug inputs of the other timers.
- adjust Timer S4 that the display shows "0:00.00" (A-timer, B-timer and C-timer)
- press red and yellow button (6+7) together -the display must show "SY 0:00:00"
- make all other timers ready for a synchronize start (all devices have to be connected by cable 004, or banana plug jumper)
- by pressing toggle switch (8) downwards it makes a synchronize start
- all connected timers show now a running time on the display

Synchronize start for 18-Channel-Timer with time of day:

- connect all timers with synchronize cable 004 (or banana plug jumper)
- adjust Timer S4 that the display shows "0:00.00" (A-timer, B-timer and C-timer)
- press red and yellow button (6+7) together
- the display (1) must show "HP 0:00:00"
- input time of day (red button (6) = hours; yellow button (7) = minutes)
- make all other timers ready for a synchronize start (all devices have to be connected by cable 004)
- by pressing toggle switch (8) downwards it makes a synchronize start
- all connected timers show now a running time on the display

3. TIMING

In order to select a program you have to press the toggle switch (8) upwards (position program+line test) during turning the device on (switch (17)). Now you can select the program by pressing the yellow button (7). The display shows the program number and version number of the software.

If you turn the Timer S4 on (switch 17), without pressing the toggle switch (8) upwards, the program that you used before will be selected automatically.

Program	Program Number
Split or Sequential	Prog. 0
3-Course-Timer	Prog. 1
Show Jumping	Prog. 2
18-Channel-Timer	Prog. 3
Parallel Slalom	Prog. 4
Speed	Prog. 5
Swimming	Prog. 6
Automatic	Prog. 7
Seconds Mode	Prog. 8

Each program has pre-adjusted options (e.g. delay time, precision, ...). This options you can change when using the program. After you turn the device off it keeps the changed options in the memory.

If you want to have the pre-installed options from ALGE back do the following:

- turn device off (switch 17)
- press the yellow button (6) down
- press toggle switch (8) upwards (position "program+line test")
- turn device on (switch 17)
- release yellow button (6) and toggle switch (8)
- select program with yellow button (6)

Headset Q34 connections:

The S4 serves as the heart of your communications system. The built in amplifier allows you to communicate on 6 channels using the Q34 headsets. The ALGE STSc series of start gates have built in amplifiers. The SV3 amplifier is designed to work with a single pair of wires for an intermediate station or at the finish line or at the start for more flexibility.

Channels that allow to connect the headset are:

channel 0, 1, 2, 3, 6, and 9 (see page 55 and 56)

Printer P4:

When using Printer P4 adjust the printing speed at "Pri = 0.1". This guarantees you a fast data transfer and printing speed (see page 21, point 2.6.8.).

Printer P3:

When using Printer P3 adjust the printing speed at "Pri = 60". If you use a shorter time it may not print all information (see page 21, point 2.6.8.)

3.1. Show Jumping (Program 2)

There are different events of show jumping. Most of this events are supplied with a special program:

Show Jumping Event	Printer output	First Stage	Second Stage	Second stage starts immediately after the first stage
Standard Show Jumping	BAREME A	bAr.A		
Standard Show Jumping in two Stages	BAREME A	bAr.A	bAr.A	
Standard Show Jumping with Stages	BAREME A BARRAGE INTEGRE	bAr.A	bAr.B (A)	
Show Jumping with Time Penalty	BAREME C	bAr.A		
Two Stage Show Jumping	BAREME A or BARRAGE			bAr.D
Standard Show Jumping with American Stage - E (Standard Show Jumping and Show Jumping with Time Penalty)	PARCOURS AMERICANE-E			bAr.E
Standard Show Jumping with American Stage - F (Standard Show Jumping for First and Second Stage)	PARCOURS AMERICANE-F			bAr.F
Program for Coach	BAREME H	bAr.H		
Standard Show Jumping and Show Jumping with Time Penalty	BAREME A ET C			bAr.I
Dog: Agility	HUNDESPORT PRUEFUNG	bAr.P		
Dog: Agility Gambler	HUNDESPORT GAMBLER	bAr.G		

3.1.1. Standard Show Jumping (Bareme A)

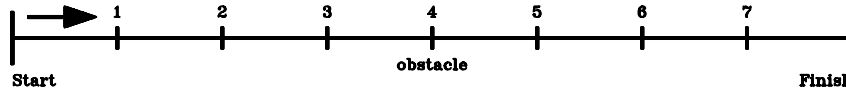

Standard Show Jumping (Bareme A) adds 1/4 point per second time violation.

Choose the program:

- set toggle switch to (5) to position "A-timer"
- press toggle switch (8) upwards (position "program+line test")
- turn device on (switch 17)
- release toggle switch (8)
- select program 2 with yellow button (7)
- if the display (1) shows "Pr.2" and the version number, press the red and yellow button (6+7) together
- press yellow button (7) as many times until it shows in display (1) "bAr. A"
- press toggle switch (8) down (position "delay time")
- it prints "Bareme A" on the printer, the display (1) shows "LI 00"

Input the maximum allowed time:

- input the allowed time:
 - o increase 10 seconds with red button (6)
 - o increase 1 second with the yellow button (7)
- store maximum allowed by pressing toggle switch (8) down (position "delay time")

Input the countdown time:

- display shows "CdSH 45"
- input countdown time:
 - o with the yellow button (7) you can change between 30, 45, 60 and 0 seconds
 - o with the red button (6) you can increase the countdown time one second.
 - o CdSH means automatic start at countdown 0 and a short hoot.
 - o Cancel the automatic start resp. the hoot by pressing toggle switch (8) upwards. On the display you will see Cd resp. CDS resp. CDSH.
- store countdown time by pressing toggle switch (8) down (position "delay time")
- display shows still the countdown time, the printer prints clear round time and countdown time

Start the countdown:

- start with handswitch (plugged at red/black banana socket 18) or with red button (6). The loudspeaker honks.
- at the end of the countdown it starts to honk. (If selected above)

Start:

- set toggle switch (5) on position "A-timer"
- Timer S4 receives a start impulse from the start photocell)
- display (1) shows the running time

Time-out for set up of obstacle drop:

- press red button (6) or time-out handswitch
- speaker honks at the beginning of the time-out
- input the penalty seconds with the yellow button (7) until it shows the correct one in the display (0, 4, 6, 8 or 10 penalty seconds are possible)
- press red button (6) or time-out handswitch to finish the time-out period
- speaker honks at the end of the time-out
- the display (1) shows now the penalty seconds and the running time

Attention: if you set the wrong penalty seconds continue to press the yellow button (7) until it shows the correct value.

Penalty points for obstacle drop (4 points):

- push toggle switch to position "B-timer"
- input penalty points with yellow button (7) (you can choose between 0, 4 and 8 points)
- push toggle switch to position "A-timer"

Penalty points (input from 1 to 8 points):

- push toggle switch to position "C-timer"
- input penalty points with yellow button (7) (you can choose from 1 to 8, or 0 points)
- push toggle switch to position "A-timer"

Timing the clear round time:

- wait until you receive the stop impulse of the finish photocell
- clear round time is shown in display (1) (toggle switch (5) needs to be on position "A-timer"

Final result:

- press red button (6) after the rider passes the finish and the printer stops printing
- the printer starts to print the final result (total time, penalty points of time violation, total penalty points)
- the display (1) shows the total time on position "A-timer", the total penalty points on position "B-timer"

Reset of the clock:

- press the yellow button (7) and hold it down
- press the red button (6)
- release both buttons (6+7)

Attention: You need to have the toggle switch (5) on position "A-timer" during the start, because it won't take the start impulse when you are on another switch position.

Suppression and correction of false impulses:

- ten seconds after the start and during the time-out the system takes no finish impulses
- if you receive a false finish impulse:
press the yellow button (6), the time runs again

Pre-adjustment of the options:

- dF-1.0 finish-delay time = 1.0 seconds
- dS-9.9 start-delay time = 9.9 seconds
- LZE = EIN running tenth seconds are on
- LF CH1-2 running time for display board interface is on channel 1 and 2
- TAU AUS precision is 1/100 seconds
- HUN Ein precision is 1/100 seconds
- Pri 6.0 printer speed for Printer P3
- Lr 0 printer prints in every line

Printer P4: example of a print output:

* SAUT D'OBSTACLES *		
BAREME A		
TMPL	055 sec.	maximum allowed time
CD	30 sec.	countdown-time

CD	21 sec.	start 21 seconds before the countdown ends
TO	017.92	time-out after 17.92 seconds
PS	6 sec.	6 penalty seconds
PP	4.00	4 penalty points for obstacle drop
TO	45.83	time-out after 45.83 seconds
PS	8 sec.	8 penalty seconds
LZ	55.35	clear round time
PP TM	0.25	penalty points from clear round time
PP	4.25	penalty points from clear round time and obstacle drop

TZ	69.35	total time (clear round time with penalty seconds)
PP TM	3.75	penalty points of the total time
PP	7.75	total points (total time and obstacle drop)
=====		

Display Board GAZc:

It is possible to show the time and penalty points on two display boards (connection drawing see page 12). The display board that shows the time must be set on "min - sec - 1/100", the display board that shows the points on "no. - rank".

Computer output through RS 232 interface:

The interface from the Timer S4 to a computer is the outlet RS232 (15).

Transfer format: 4800 baud, 1 start bit, 8 ASCII-bit, no parity-bit, 1 stop bit

Data format: #####xTNxxHH:MM:SS.zht(CR)
#####xPPxx00:00:0p.000(CR)
#####xPSxx00:00:0s.000(CR)

####	continuous ID number (4-digits)
TN	identification for clear round time
PP	identification for penalty points
PS	identification for penalty seconds
HH:MM:SS.zht	time in hours, minutes, seconds and thousandths
p	penalty points
s	penalty seconds
x	blank
(CR)	carriage return

Toggle switch A-timer, B-timer, C-timer (5):

Normally the toggle switch (5) is on position "A-timer". The display (1) shows the countdown time or running time.

To input the four penalty points for obstacle drop switch on position "B-timer"

To input the penalty points for balking switch on position "C-timer"

3.1.2. Standard Show Jumping in two stages

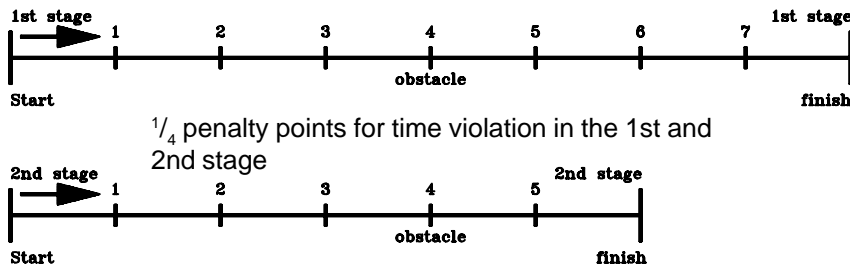

You have to operate the Timer S4 exactly like described for standard show jumping for the first stage (see point 3.1.1.).

Jump off (second stage, barrage):

The operation is the same as for the first stage, if the rider had no penalty points in the first stage.

If the rider had penalty points in the first stage you must input them before you start the second stage:

- set toggle switch (5) to "B-timer"
- input penalty points from the first stage
 - o red button (6) to increase one point
 - o yellow button (7) to increase 1/4 point
- display (1) show the penalty points
- move toggle switch (5) back to position "A-timer" (on position "B-timer" it does not take the start impulse)
- now you continue to operate like for the standard show jumping (see point 3.1.1.)

3.1.3. Standard Show Jumping with Stage (Bareme B)

First Round:

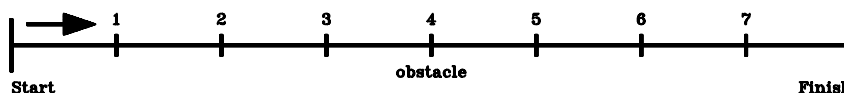

1 penalty point for each started second time violation

- Operate the Timer S4 for the first stage like for the Standard Show Jumping (see point 3.1.1.)
- Qualified for the second stage is everybody without penalty points from the first stage

Jump off (second round):

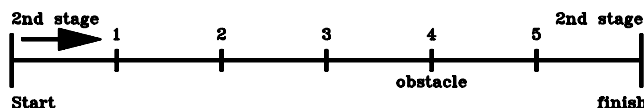

1 penalty point for each started second time violation

Choose the program:

- press toggle switch (8) upwards (position "program+line test")
- turn device on (switch 17)
- release toggle switch (8)
- select program 2 with yellow button (7)
- if the display (1) shows "Pr.2" and the version number, press the red and yellow button (6+7) together
- press yellow button (7) as many times until it shows in display (1) "bAr. B"
- press toggle switch (8) down (position "delay time")
- it prints "Barage" on the printer, the display (1) shows "LI 00"

You operate this program like the Standard Show Jumping (see point 3.1.1.). The only difference to the Standard Show Jumping is that it calculates 1 point for each second time violation (0.25 seconds at the Standard Show Jumping).

3.1.4. Show Jumping with Time Penalty (Bareme C)

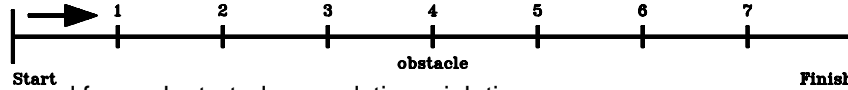

1 penalty second for each started second time violation

In this mode are no penalty points, but penalty seconds. For each obstacle drop you have to add 3 to 8 penalty seconds, depending on the length of the parcours and the amount of obstacles.

Choose the program:

- press toggle switch (8) upwards (position "program+line test")
- turn device on (switch 17)
- release toggle switch (8)
- select program 2 with yellow button (7)
- if the display (1) shows "Pr.2" and the version number, press the red and yellow button (6+7) together
- press yellow button (7) as many times until it shows in display (1) "bAr. C"
- press toggle switch (8) down (position "delay time")
- it prints "Bareme C" on the printer, the display (1) shows "PS 1"

Input the amount of penalty seconds for obstacle drop:

- input penalty seconds for obstacle drop:
 - o increase 1 second with the yellow button (7) (adjustment from 1 to 25 is possible)
- store penalty seconds by pressing toggle switch (8) down (position "delay time")

Input the maximum allowed time:

- input the maximum allowed time:
 - o increase 10 seconds with red button (6)
 - o increase 1 second with the yellow button (7)
- store maximum allowed time by pressing toggle switch (8) down (position "delay time")

Input the countdown time:

- display shows "CdSH 45"
- input countdown time:
 - o with the yellow button (7) you can change between 30, 45, 60 and 0 seconds
 - o with the red button (6) you can increase the countdown time one second.
 - o CdSH means automatic start at countdown 0 and a short hoot.
 - o Cancel the automatic start resp. the hoot by pressing toggle switch (8) upwards. On the display you will see Cd resp. CDS resp. CDSH.
- store countdown time by pressing toggle switch (8) down (position "delay time")
- display shows still the countdown time, the printer prints clear round time and countdown time

Start the countdown:

- start with handswitch (plugged at red/black banana socket 18) or with red button (6). The loudspeaker honks.
- at the end of the countdown it starts to honk. (If selected above)

Start:

- set toggle switch (5) on position "A-timer"
- Timer S4 receives a start impulse from the start photocell)
- display (1) shows the running time

Time-out for set up of obstacle drop:

- press red button (6) or time-out handswitch
- speaker honks at the beginning of the time-out
- input the penalty seconds with the yellow button (7) until it shows the correct one in the display (0, 4, 6, 8 or 10 penalty seconds are possible)
- press red button (6) or time-out handswitch to finish the time-out period
- speaker honks at the end of the time-out
- the display (1) shows now the penalty seconds and the running time

Attention: if you set the wrong penalty seconds continue to press the yellow button (7) until it shows the correct value.

Penalty seconds for obstacle drop:

- push toggle switch (5) to position "B-timer" or "C-timer"
- input penalty seconds with yellow button (7) (0 or stored penalty seconds are possible)
- push toggle switch to position "A-timer"

Timing the clear round time:

- wait until you receive the stop impulse of the finish photocell
- clear round time is shown in display (1) (toggle switch (5) needs to be on position "A-timer"

Final result:

- press red button (6) after the rider passes the finish and printer stops printing
- the printer starts to print the total time
- the display (1) shows the total time on position "A-timer", the total penalty seconds on position "B-timer"

Reset of the clock:

- press the yellow button (7) and hold it down
- press the red button (6)
- release both buttons (6+7)

Attention: You need to have the toggle switch (5) on position "A-timer" during the start, because it won't take the start impulse when you are on another switch position.

Suppression and correction of false impulses:

- ten seconds after the start and during the time-out the system takes no finish impulses
- if you receive a false finish impulse:
 press the yellow button (6), the time runs again

Pre-adjustment of the options:

- dF-1.0 finish-delay time = 1.0 seconds
- dS-9.9 start-delay time = 9.9 seconds
- LZE = EIN running tenth seconds are on
- LF CH1-2 running time for display board interface is on channel 1 and 2
- TAU AUS precision is 1/100 seconds
- HUN Ein precision is 1/100 seconds
- Pri 6.0 printer speed for Printer P3
- Lr 0 printer prints in every line

Printer P4: example of a print output:

BAREME C		
TMPL	050 sec.	maximum allowed time
CD	30 sec.	countdown-time

CD	16 sec.	start 16 seconds before the countdown ends
TO	012.63	time-out after 17.92 seconds
PS	6 sec.	6 penalty seconds
PS	5 sec.	5 penalty seconds for obstacle drop
PS	5 sec.	5 penalty seconds for obstacle drop
LN	51.88	clear round time including 6 sec. from time-out
PP TM	2 sec,	penalty points from time violation

TT	63.88	total time = 51.88 + 5 + 5 + 2 = 63,88
=====		

Display Board GAZc:

It is possible to show the time and penalty points on two display boards (connection drawing see page 12). The display board that shows the time must be set on "min - sec - 1/100", the display board that shows the points on "no. - rank".

Computer output through RS 232 interface:

The interface from the Timer S4 to a computer is the outlet RS232 (15).

Transfer format: 4800 baud, 1 start bit, 8 ASCII-bit, no parity-bit, 1 stop bit

Data format: #####xTNxxHH:MM:SS.zht(CR)
#####xPSxx00:00:0s.000(CR)

#####	continuous ID number (4-digits)
TN	identification for clear round time
PS	identification for penalty seconds
HH:MM:SS.zht	time in hours, minutes, seconds and thousandths
s	penalty seconds
x	blank
(CR)	carriage return

Toggle switch A-timer, B-timer, C-timer (5):

Normally the toggle switch (5) is on position "A-timer". The display (1) shows the countdown time or running time.

To input the penalty seconds for obstacle drop switch on position "B-timer" or "C-timer"

3.1.5. Two Stage Show Jumping (Bareme A Barrage Integre)

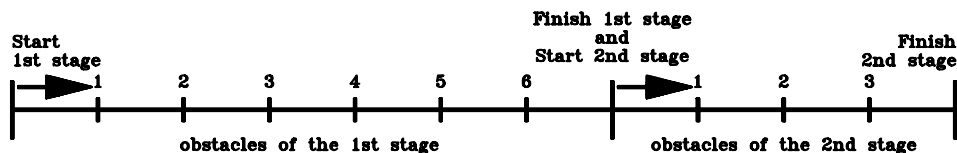

Each rider that has an obstacle drop or time violation during the first round is not qualified for the second round.

International Rules old:

First Round: $\frac{1}{4}$ point per started second time violation

Second Round: 1 point per started second time violation

Switzerland:

First and Second Round: $\frac{1}{4}$ point per started second time violation

International new:

First and Second Round: 1 point per started second time violation

Choose the program (International old):

- set toggle switch to (5) to position "A-timer"
- press toggle switch (8) upwards (position "program+line test")
- turn device on (switch 17)
- release toggle switch (8)
- select program 2 with yellow button (7)
- if the display (1) shows "Pr.2" and the version number, press the red and yellow button (6+7) together
- press yellow button (7) as many times until it shows in display (1) "bAr. d"
- press toggle switch (8) down (position "delay time")
- it prints "BAREME A BARRAGE INTEGRE" on the printer, the display (1) shows "L1 00"

Choose the program (International new):

- set toggle switch (5) to position "C-timer"
- press toggle switch (8) upwards (position "program+line test")
- turn device on (switch 17)
- release toggle switch (8)
- select program 2 with yellow button (7)
- if the display (1) shows "Pr.2" and the version number, press the red and yellow button (6+7) together
- press yellow button (7) as many times until it shows in display (1) "bAr. d"
- press toggle switch (8) down (position "delay time")
- it prints "BAREME A BARRAGE INTEGRE" on the printer, the display (1) shows "L1 00"

Choose the program (Switzerland):

- The same like "International new". **ATTENTION:** Set toggle switch (5) to position "B-timer".

Input the maximum allowed time:

- input the maximum allowed time for the first stage (display (1) shows "L1 00":
 - o increase 10 seconds with red button (6)
 - o increase 1 second with the yellow button (7)
- store maximum allowed time by pressing toggle switch (8) down (position "delay time")
- input the maximum allowed time for the second stage (display (1) shows "L2 00":
 - o increase 10 seconds with red button (6)
 - o increase 1 second with the yellow button (7)
- store maximum allowed time by pressing toggle switch (8) down (position "delay time")

Input the countdown time:

- display shows "CdSH 45"
- input countdown time:
 - o with the yellow button (7) you can change between 30, 45, 60 and 0 seconds
 - o with the red button (6) you can increase the countdown time one second.
 - o CdSH means automatic start at countdown 0 and a short hoot.
 - o Cancel the automatic start resp. the hoot by pressing toggle switch (8) upwards. On the display you will see Cd resp. CDS resp. CDSH.
- store countdown time by pressing toggle switch (8) down (position "delay time")
- display shows still the countdown time, the printer prints clear round time and countdown time

Start the countdown:

- start with handswitch (plugged at red/black banana socket 18) or with red button (6). The loudspeaker honks.
- at the end of the countdown it starts to honk. (If selected above)

Start:

- set toggle switch (5) on position "A-timer"
- Timer S4 receives a start impulse from the start photocell)
- display (1) shows the running time

Time-out for set up of obstacle drop:

- press red button (6) or time-out handswitch
 - speaker honks at the beginning of the time-out
 - input the penalty seconds with the yellow button (7) until it shows the correct one in the display (0, 4, 6, 8 or 10 penalty seconds are possible)
 - press red button (6) or time-out handswitch to finish the time-out period
 - speaker honks at the end of the time-out
 - the display (1) shows now the penalty seconds and the running time
- Attention: if you set the wrong penalty seconds continue to press the yellow button (7) until it shows the correct value.

Penalty points for obstacle drop (4 points):

- push toggle switch to position "B-timer"
- input penalty points with yellow button (7) (you can choose between 0, 4 and 8 points)
- push toggle switch to position "A-timer"

Penalty points (input from 1 to 8 points):

- push toggle switch to position "C-timer"
- input penalty points with yellow button (7) (you can choose from 1 to 8, or 0 points)
- push toggle switch to position "A-timer"

Timing the clear round time of the first round:

- wait until you receive the stop impulse from the photocell for the second round
- clear round time is shown in display (1) (toggle switch (5) needs to be on position "A-timer"
- if the rider has no penalty points it starts to run automatically the time for the second round
- press the yellow button (7) to show the running time of the second round on the display (1)
- at the end of the first round is a rider finished, if he has penalty points (then press the red button to receive the final result)

Timing the clear round time of the second round:

- wait until you receive the stop impulse from the photocell for the second round
- clear round time is shown in display (1) (toggle switch (5) needs to be on position "A-timer"

Final result:

- press red button (6) after the rider passes the finish of the second round and the printer stops printing
- the printer starts to print the final result (total time, penalty points of time violation, total penalty points)
- the display (1) shows the total time on position "A-timer", the total penalty points on position "B-timer"

Reset of the clock:

- press the yellow button (7) and hold it down
- press the red button (6)
- release both buttons (6+7)

Attention: You need to have the toggle switch (5) on position "A-timer" during the start, because it won't take the start impulse when you are on another switch position.

Suppression and correction of false impulses:

- ten seconds after the start and during the time-out the system takes no finish impulses
- if you receive a false finish impulse and the rider has penalty points: press the yellow button (6), the time runs again
- if you receive a false finish impulse and the rider has no penalty points: no correction is possible, because time starts automatically for second round

Pre-adjustment of the options:

dF-1.0	finish-delay time = 1.0 seconds
dS-9.9	start-delay time = 9.9 seconds
LZE = EIN	running tenth seconds are on
LF CH1-2	running time for display board interface is on channel 1 and 2
TAU AUS	precision is 1/100 seconds
HUN Ein	precision is 1/100 seconds
Pri 6.0	printer speed for Printer P3
Lr 0	printer prints in every line

Printer P4: example of a print output:

BAREME A BARRAGE INTREGRE		
TMPL 1	055 sec.	maximum allowed time for first round
TMPL 2	037 sec.	maximum allowed time for second round
CD	60 sec.	countdown-time

CD	15 sec.	start 15 seconds before the countdown ends
TN	53.56	clear round time of first round
PP TM	*00.00*	no penalty points from clear round time
PP	*00.00*	no penalty points from clear round time and obstacle drop

PP	4.00	penalty point for obstacle drop
TO	17.45	time out after 17.45 sec. of the second round
PS	6 sec.	penalty seconds during time-out
TN	38.39	clear round time of the second round
PP TM	*02.00*	penalty points for time violation
PP	*6.00*	penalty points (obstacle drop and time violation)

TT	44.39	total time (clear round time and penalty time)
PP TN	*08.00*	penalty points from time violation of total time
PP	*12.00*	total points (total time and obstacle drop)
=====		

Display Board GAZc:

It is possible to show the time and penalty points on two display boards (connection drawing see page 12). The display board that shows the time must be set on "min - sec - 1/100", the display board that shows the points on "no. - rank".

The interface "display board"(19) is adjusted that it outputs on both channels the running time.

Computer output through RS 232 interface:

The interface from the Timer S4 to a computer is the outlet RS232 (15).

Transfer format: 4800 baud, 1 start bit, 8 ASCII-bit, no parity-bit, 1 stop bit

Data format: #####xTNxxHH:MM:SS.zht(CR)
#####xPPxx00:00:0p.000(CR)
#####xPSxx00:00:0s.000(CR)
continuous ID number (4-digits)
TN identification for clear round time
PP identification for penalty points
PS identification for penalty seconds
HH:MM:SS.zht time in hours, minutes, seconds and thousandths
p penalty points
s penalty seconds
x blank
(CR) carriage return

**3.1.6. Standard Show Jumping with American Jump Off - E
(Parcours Americains E)**

(Standard Show Jumping and Show Jumping with Time Penalty):

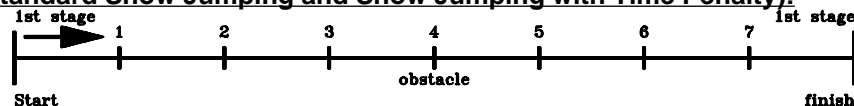

Adds for e.g. 0.25 points per started second time violation

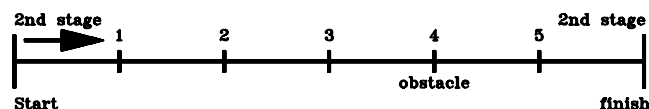

Adds 1 sec. per started second time violation

Each rider that has an obstacle drop or time violation during the first round is not qualified for the second round.

International:

First and Second Round: 1 point per started second time violation
Preparation time for the 2nd round is 30 seconds.

National:

First Round: 1/4 point per started second time violation
Second Round: 1 point per started second time violation
Preparation time for the 2nd round is 30 seconds.

National (Italy):

First Round: 1 point per started second time violation
Second Round: 1 point per started second time violation
Preparation time for the 2nd round is 45 seconds.

Choose the program (International):

- set toggle switch (5) to position "C-timer"
- press toggle switch (8) upwards (position "program+line test")
- turn device on (switch 17)
- release toggle switch (8)
- select program 2 with yellow button (7)
- if the display (1) shows "Pr.2" and the version number, press the red and yellow button (6+7) together
- press yellow button (7) as many times until it shows in display (1) "bAr. E"
- press toggle switch (8) down (position "delay time")
- it prints "Bareme A" on the printer, the display (1) shows "L1 00"

Choose the program (national Italy):

same settings as described above, but:

- set toggle switch to (5) to position "B-timer"

Choose the program (national):

same settings as described above, but:

- set toggle switch to (5) to position "A-timer"

Input the amount of penalty seconds for obstacle drop:

- input penalty seconds for obstacle drop:
 - o increase 1 second with the yellow button (7) (input from 1 to 25 is possible)
- store penalty seconds by pressing toggle switch (8) down (position "delay time")

Input the maximum allowed time:

- input the maximum allowed time for the first stage (display (1) shows "L1 00":
 - o increase 10 seconds with red button (6)
 - o increase 1 second with the yellow button (7)
- store maximum allowed time by pressing toggle switch (8) down (position "delay time")
- input the maximum allowed time for the second stage (display (1) shows "L2 00":
 - o increase 10 seconds with red button (6)
 - o increase 1 second with the yellow button (7)
- store maximum allowed time by pressing toggle switch (8) down (position "delay time")

Input the countdown time:

- display shows "CdSH 45"
- input countdown time:
 - o with the yellow button (7) you can change between 30, 45, 60 and 0 seconds
 - o with the red button (6) you can increase the countdown time one second.
 - o CdSH means automatic start at countdown 0 and a short hoot.
 - o Cancel the automatic start resp. the hoot by pressing toggle switch (8) upwards. On the display you will see Cd resp. CDS resp. CDSH.
- store countdown time by pressing toggle switch (8) down (position "delay time")
- display shows still the countdown time, the printer prints clear round time and countdown time

Start the countdown:

- start with handswitch (plugged at red/black banana socket 18) or with red button (6). The loudspeaker honks.
- at the end of the countdown it starts to honk. (If selected above)

Start:

- set toggle switch (5) on position "A-timer"
- Timer S4 receives a start impulse from the start photocell)
- display (1) shows the running time

Time-out for set up of obstacle drop:

- press red button (6) or time-out handswitch
- speaker honks at the beginning of the time-out
- input the penalty seconds with the yellow button (7) until it shows the correct one in the display (0, 4, 6, 8 or 10 penalty seconds are possible)
- press red button (6) or time-out handswitch to finish the time-out period
- speaker honks at the end of the time-out
- the display (1) shows now the penalty seconds and the running time

Attention: if you set the wrong penalty seconds continue to press the yellow button (7) until it shows the correct value.

Penalty points for obstacle drop (4 points):

- push toggle switch to position "B-timer"
- input penalty points with yellow button (7) (you can choose between 0, 4 and 8 points)
- push toggle switch to position "A-timer"

Penalty points (input from 1 to 8 points):

- push toggle switch to position "C-timer"
- input penalty points with yellow button (7) (you can choose from 1 to 8, or 0 points)
- push toggle switch to position "A-timer"

Timing of the clear round time of the 1st round:

- wait until you receive the stop impulse of the finish photocell from the 1st round
- clear round time is shown in display (1) (toggle switch (5) needs to be on position "A-timer")
- the rider is qualified for the second round if he finishes the 1st round without penalty points
- press red button (6) to start the 30 second countdown for the 2nd round (if no penalty points), or to print the final result (if penalty points)

Penalty seconds for obstacle drop:

- push toggle switch (5) to position "B-timer" or "C-timer"
- input penalty seconds with yellow button (7) (0 or stored penalty seconds are possible)
- push toggle switch to position "A-timer"

Timing of the clear round time of the 2nd round:

- wait until you receive the stop impulse of the finish photocell from the 2nd round
- clear round time is shown in display (1) (toggle switch (5) needs to be on position "A-timer")

Final result:

- press red button (6) after the rider passes the finish and the printer stops printing
- the printer starts to print the final result (total time)
- the display (1) shows the total time on position "A-timer", the total penalty seconds on position "B-timer"

Attention: The calculation works only up to 99.99 seconds.

Reset of the clock:

- press the yellow button (7) and hold it down
- press the red button (6)
- release both buttons (6+7)

Attention: You need to have the toggle switch (5) on position "A-timer" during the start, because it won't take the start impulse when you are on another switch position.

Suppression and correction of false impulses:

- ten seconds after the start and during the time-out the system takes no finish impulses
- if you receive a false finish impulse:
 press the yellow button (6), the time runs again

Pre-adjustment of the options:

dF-1.0	finish-delay time = 1.0 seconds
dS-9.9	start-delay time = 9.9 seconds
LZE = EIN	running tenth seconds are on
LF CH1-2	running time for display board interface is on channel 1 and 2
TAU AUS	precision is 1/100 seconds
HUN Ein	precision is 1/100 seconds
Pri 6.0	printer speed for Printer P3
Lr 0 p	printer prints in every line

Printer P4: example of a print output:

PARCOURS AMERICANS-E		
TMPL1	055 sec.	maximum allowed time for the 1st round
TMPL2	038 sec.	maximum allowed time for the 2nd round
CD	60 sec.	countdown-time

CD	23 sec.	1st round start 23 seconds before the countdown ends
TN	53.77	clear round time of the first round
PP TM	*00.00*	no penalty seconds for time violation
PP	*00.00*	no points for obstacle drop

CD	12 sec.	2nd round (jump off) start 12 seconds before the countdown ends
PS	4 sec.	4 penalty seconds for obstacle drop
TO	23.45	Time-out after 23.45 seconds of the 2nd round
PS	6 sec.	6 penalty seconds from time-out
PS	4 sec.	4 penalty seconds
TN	39.04	clear round time (including 6 penalty seconds)
PP TM	*02.00*	penalty points for time violation during jump off

TT	47.04	total time (clear round time with penalty seconds)
=====		

Display Board GAZc:

It is possible to show the time and penalty points on two display boards (connection drawing see page 12). The display board that shows the time must be set on "min - sec - 1/100", the display board that shows the points on "no. - rank".

The interface "display board"(19) is adjusted that it outputs on both channels the running time.

Computer output through RS 232 interface:

The interface from the Timer S4 to a computer is the outlet RS232 (15).

Transfer format: 4800 baud, 1 start bit, 8 ASCII-bit, no parity-bit, 1 stop bit

Data format: #####xTNxxHH:MM:SS.zht(CR)
#####xPPxx00:00:0p.000(CR)
#####xPSxx00:00:0s.000(CR)
continuous ID number (4-digits)
TN identification for clear round time
PP identification for penalty points
PS identification for penalty seconds
HH:MM:SS.zht time in hours, minutes, seconds and thousandths
p penalty points
s penalty seconds
x blank
(CR) carriage return

**3.1.7. Standard Show Jumping with American Jump Off - F
(Parcours Americains F)**

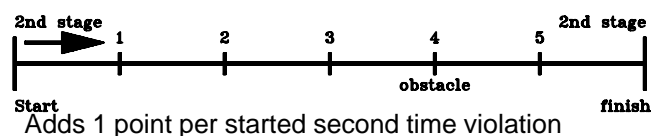
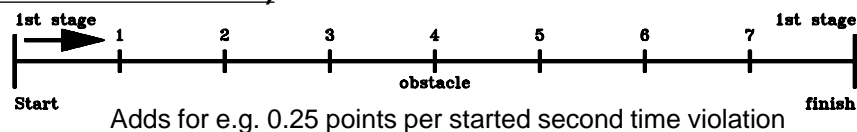

Each rider that has an obstacle drop or time violation during the first round is not qualified for the second round.

International:

First and Second Round: 1 point per started second time violation
Preparation time for the 2nd round is 30 seconds.

National:

First Round: $\frac{1}{4}$ point per started second time violation
Second Round: 1 point per started second time violation
Preparation time for the 2nd round is 30 seconds.

National (Italy):

First Round: 1 point per started second time violation
Second Round: 1 point per started second time violation
Preparation time for the 2nd round is 45 seconds.

Choose the program (International):

- set toggle switch (5) to position "C-timer"
- press toggle switch (8) upwards (position "program+line test")
- turn device on (switch 17)
- release toggle switch (8)
- select program 2 with yellow button (7)
- if the display (1) shows "Pr.2" and the version number, press the red and yellow button (6+7) together
- press yellow button (7) as many times until it shows in display (1) "bAr. F"
- press toggle switch (8) down (position "delay time")
- it prints "Bareme A" on the printer, the display (1) shows "L1 00"

Choose the program (national Italy):

same settings as described above, but:

- set toggle switch to (5) to position "B-timer"

Choose the program (national):

same settings as described above, but:

- set toggle switch to (5) to position "A-timer"

Input the maximum allowed time:

- input the maximum allowed time for the first stage (display (1) shows "L1 00":
 - o increase 10 seconds with red button (6)
 - o increase 1 second with the yellow button (7)
- store maximum allowed time by pressing toggle switch (8) down (position "delay time")
- input the maximum allowed time for the second stage (display (1) shows "L2 00":
 - o increase 10 seconds with red button (6)
 - o increase 1 second with the yellow button (7)
- store maximum allowed time by pressing toggle switch (8) down (position "delay time")

Input the countdown time:

- display shows "CdSH 45"
- input countdown time:
 - o with the yellow button (7) you can change between 30, 45, 60 and 0 seconds
 - o with the red button (6) you can increase the countdown time one second.
 - o CdSH means automatic start at countdown 0 and a short hoot.
 - o Cancel the automatic start resp. the hoot by pressing toggle switch (8) upwards. On the display you will see Cd resp. CDS resp. CDSH.
- store countdown time by pressing toggle switch (8) down (position "delay time")
- display shows still the countdown time, the printer prints clear round time and countdown time

Start the countdown:

- start with handswitch (plugged at red/black banana socket 18) or with red button (6). The loudspeaker honks.
- at the end of the countdown it starts to honk. (If selected above)

Start:

- set toggle switch (5) on position "A-timer"
- Timer S4 receives a start impulse from the start photocell)
- display (1) shows the running time

Time-out for set up of obstacle drop:

- press red button (6) or time-out handswitch
- speaker honks at the beginning of the time-out
- input the penalty seconds with the yellow button (7) until it shows the correct one in the display (0, 4, 6, 8 or 10 penalty seconds are possible)
- press red button (6) or time-out handswitch to finish the time-out period
- speaker honks at the end of the time-out
- the display (1) shows now the penalty seconds and the running time

Attention: if you set the wrong penalty seconds continue to press the yellow button (7) until it shows the correct value.

Penalty points for obstacle drop (4 points):

- push toggle switch to position "B-timer"
- input penalty points with yellow button (7) (you can choose between 0, 4 and 8 points)
- push toggle switch to position "A-timer"

Penalty points (input from 1 to 8 points):

- push toggle switch to position "C-timer"
- input penalty points with yellow button (7) (you can choose from 1 to 8, or 0 points)
- push toggle switch to position "A-timer"

Timing of the clear round time of the 1st round:

- wait until you receive the stop impulse of the finish photocell from the 1st round
- clear round time is shown in display (1) (toggle switch (5) needs to be on position "A-timer")
- the rider is qualified for the second round if he finishes the 1st round without penalty points
- press red button (6) to start the 30 second countdown for the 2nd round (if no penalty points), or to print the final result (if penalty points)

Timing of the clear round time of the 2nd round:

- wait until you receive the stop impulse of the finish photocell from the 2nd round
- clear round time is shown in display (1) (toggle switch (5) needs to be on position "A-timer")

Final result:

- press red button (6) after the rider passes the finish and the printer stops printing
- the printer starts to print the final result (total time, penalty points for time violation, total penalty points)
- the display (1) shows the total time on position "A-timer", the total penalty seconds on position "B-timer"

Attention: The calculation works only up to 99.99 seconds.

Reset of the clock:

- press the yellow button (7) and hold it down
- press the red button (6)
- release both buttons (6+7)

Attention: You need to have the toggle switch (5) on position "A-timer" during the start, because it won't take the start impulse when you are on another switch position.

Suppression and correction of false impulses:

- ten seconds after the start and during the time-out the system takes no finish impulses
- if you receive a false finish impulse:

press the yellow button (6), the time runs again **Pre-adjustment of the options:**

- dF-1.0 finish-delay time = 1.0 seconds
- dS-9.9 start-delay time = 9.9 seconds
- LZE = EIN running tenth seconds are on
- LF CH1-2 running time for display board interface is on channel 1 and 2
- TAU AUS precision is 1/100 seconds
- HUN Ein precision is 1/100 seconds
- Pri 6.0 printer speed for Printer P3

Printer P4: example of a print output:

PARCOURS AMERICANS-F		
TMPL1	055 sec.	maximum allowed time for the 1st round
TMPL2	038 sec.	maximum allowed time for the 2nd round
CD	60 sec.	countdown-time

1st round		
CD	23 sec.	start 23 seconds before the countdown ends
TN	53.77	clear round time of the first round
PP TM	*00.00*	no penalty seconds for time violation
PP	*00.00*	no points for obstacle drop

2nd round (jump off)		
CD	12 sec.	start 12 seconds before the countdown ends
PP	4.00	4 penalty points for obstacle drop
TO	23.45	Time-out after 23.45 seconds of the 2nd round
PS	6 sec.	6 penalty seconds from time-out
TN	39.04	clear round time (including 6 penalty seconds)
PP TM	*02.00*	penalty points for time violation during jump off
PP	*10.00*	penalty points for time violation and obstacle drop

TT	45.04	total time (clear round time with penalty seconds)
PP TN	*08.00*	penalty points for time violation
PP	*16.00*	total penalty points (time violation and obstacle drop)
=====		

Display Board GAZc:

It is possible to show the time and penalty points on two display boards (connection drawing see point 2.2). The display board that shows the time must be set on "min - sec - 1/100", the display board that shows the points on "no. - rank".

The interface "display board"(19) is adjusted that it outputs on both channels the running time.

Computer output through RS 232 interface:

The interface from the Timer S4 to a computer is the outlet RS232 (15).

Transfer format: 4800 baud, 1 start bit, 8 ASCII-bit, no parity-bit, 1 stop bit

Data format: #####xTNxxHH:MM:SS.zht(CR)

#####xPPxx00:00:0p.000(CR)

#####xPSxx00:00:0s.000(CR)

####	continuous ID number (4-digits)
TN	identification for clear round time
PP	identification for penalty points
PS	identification for penalty seconds
HH:MM:SS.zht	time in hours, minutes, seconds and thousandths
p	penalty points
s	penalty seconds
x	blank
(CR)	carriage return

3.1.8. Carriage Driving

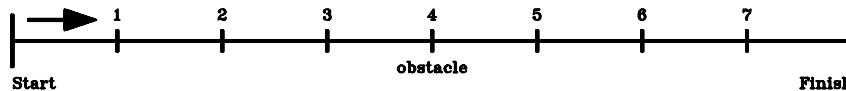

This program works like "Standard Show Jumping (Bareme A)", except that you can input the penalty point factor for time violation (0.01 to 1 second)

Choose the program:

- press toggle switch (8) upwards (position "program+line test")
- turn device on (switch 17)
- release toggle switch (8)
- select program 2 with yellow button (7)
- if the display (1) shows "Pr.2" and the version number, press the red and yellow button (6+7) together
- press yellow button (7) as many times until it shows in display (1) "bAr. H"
- press toggle switch (8) down (position "delay time")
- it prints "Bareme A" on the printer, the display (1) shows "PPS 00.25"

Input penalty points for time violation:

- input penalty points for time violation:
 - o increase 0.1 seconds with red button (6)
 - o increase 0.01 seconds with the yellow button (7)
- store maximum allowed by pressing toggle switch (8) down (position "delay time")

Input the countdown time:

- display shows "CdSH 45"
- input countdown time:
 - o with the yellow button (7) you can change between 30, 45, 60 and 0 seconds
 - o with the red button (6) you can increase the countdown time one second.
 - o CdSH means automatic start at countdown 0 and a short hoot.
 - o Cancel the automatic start resp. the hoot by pressing toggle switch (8) upwards. On the display you will see Cd resp. CDS resp. CDSH.
- store countdown time by pressing toggle switch (8) down (position "delay time")
- display shows still the countdown time, the printer prints clear round time and countdown time

From now on you can continue as for the "Standard Show Jumping (Bareme A)" (see point 3.1.1.). Input the allowed clear round time, countdown time, etc.

3.1.9. Standard Show Jumping combined with Show Jumping with Time Penalty

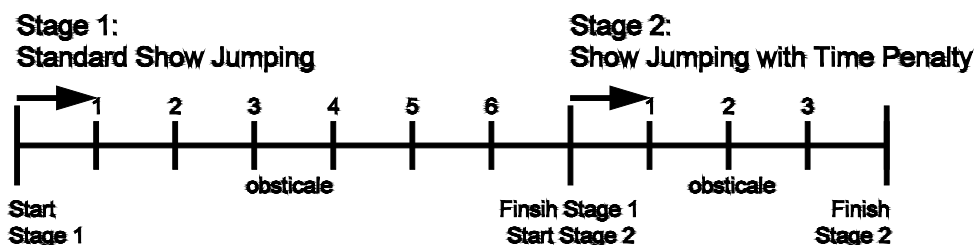

OLD:

- 1st. Round:** Standard Show Jumping. Adds $\frac{1}{4}$ penalty points per started second time violation.
- 2nd Round:** Standard Show Jumping. Adds 1 penalty second per started second time violation.

NEW:

- 1st. and 2nd Round:** Standard Show Jumping adds 1 penalty second per started second time violation

Choose the program (OLD):

- Push toggle switch (5) to position "A-timer"
- press toggle switch (8) upwards (position "program+line test")
- turn device on (switch 17); release toggle switch (8)
- select program 2 with yellow button (7)
- if the display (1) shows "Pr.2" and the version number, press the red and yellow button (6+7) together
- press yellow button (7) as many times until it shows in display (1) "bAr. I"
- press toggle switch (8) down (position "delay time")
- it prints "Bareme A ET C" on the printer, the display (1) shows "PS 1"

Choose the program (NEW):

- Push toggle switch (5) to position "C-timer"
- press toggle switch (8) upwards (position "program+line test")
- turn device on (switch 17); release toggle switch (8)
- select program 2 with yellow button (7)
- if the display (1) shows "Pr.2" and the version number, press the red and yellow button (6+7) together
- press yellow button (7) as many times until it shows in display (1) "bAr. I"
- press toggle switch (8) down (position "delay time")
- it prints "Bareme A ET C" on the printer, the display (1) shows "PS 1"
- Push toggle switch (5) to position "A-timer"

Input the amount of penalty seconds for obstacle drop:

- input penalty seconds for obstacle drop:
 - o increase 1 second with the yellow button (7) (input from 1 to 25 is possible)
- store penalty seconds by pressing toggle switch (8) down (position "delay time")

Input the maximum allowed time:

- input the maximum allowed time for the first stage (display (1) shows "L1 00":
 - o increase 10 seconds with red button (6)
 - o increase 1 second with the yellow button (7)
- store maximum allowed time by pressing toggle switch (8) down (position "delay time")
- input the maximum allowed time for the second stage (display (1) shows "L2 00":
 - o increase 10 seconds with red button (6)
 - o increase 1 second with the yellow button (7)
- store maximum allowed time by pressing toggle switch (8) down (position "delay time")

Input the countdown time:

- display shows "CdS 45"
- input countdown time:
 - o with the yellow button (7) you can change between 30, 45, 60 and 0 seconds
 - o with the red button (6) you can increase the countdown time one second.
 - o CdS means automatic start at countdown 0
 - o Cancel the automatic start by pressing toggle switch (8) upwards. On the display you will see Cd.
- store countdown time by pressing toggle switch (8) down (position "delay time")
- display shows still the countdown time, the printer prints clear round time and countdown time
- Timer S4 is ready for timing.

Start the countdown:

- start with handswitch (plugged at red/black banana socket 18) or with red button (6). The loudspeaker honks.
- at the end of the countdown it starts to honk.

Start:

- set toggle switch (5) on position "A-timer"
- Timer S4 receives a start impulse from the start photocell)
- display (1) shows the running time

Time-out for set up of obstacle drop:

- press red button (6) or time-out handswitch
- speaker honks at the beginning of the time-out
- input the penalty seconds with the yellow button (7) until it shows the correct one in the display (0, 4, 6, 8 or 10 penalty seconds are possible)
- press red button (6) or time-out handswitch to finish the time-out period
- speaker honks at the end of the time-out
- the display (1) shows now the penalty seconds and the running time

Attention: if you set the wrong penalty seconds continue to press the yellow button (7) until it shows the correct value.

Penalty points for obstacle drop (4 points):

- push toggle switch to position "B-timer"
- input penalty points with yellow button (7) (you can choose between 0, 4 and 8 points)
- push toggle switch to position "A-timer"

Penalty points (input from 1 to 8 points):

- push toggle switch to position "C-timer"
- input penalty points with yellow button (7) (you can choose from 1 to 8, or 0 points)
- push toggle switch to position "A-timer"

Timing of the clear round time of the 1st round:

- wait until you receive the stop impulse of the finish photocell from the 1st round
- clear round time is shown in display (1) (toggle switch (5) needs to be on position "A-timer")
- the rider is qualified for the second round if he finishes the 1st round without penalty points. The timer starts then automatically for the 2nd round.
- press yellow button (7) to display the running time of the 2nd round.
- if the rider has penalty points during the first stage press red button (6) to print the final result

Penalty seconds for obstacle drop:

- push toggle switch (5) to position "B-timer" or "C-timer"
- input penalty seconds with yellow button (7) (0 or stored penalty seconds are possible)
- push toggle switch to position "A-timer"

Timing of the clear round time of the 2nd round:

- wait until you receive the stop impulse of the finish photocell from the 2nd round
- clear round time is shown in display (1) (toggle switch (5) needs to be on position "A-timer")

Final result:

- press red button (6) after the rider passes the finish and the printer stops printing
- the printer starts to print the final result (total time)
- the display (1) shows the total time on position "A-timer", the total penalty seconds on position "B-timer"

Reset of the clock:

- press the yellow button (7) and hold it down
- press the red button (6)
- release both buttons (6+7)

Attention: You need to have the toggle switch (5) on position "A-timer" during the start, because it won't take the start impulse when you are on another switch position.

Suppression and correction of false impulses:

- ten seconds after the start and during the time-out the system takes no finish impulses
- if you receive a false finish impulse:
 - if there are penalty points press the yellow button (6), the time runs again
 - if there are no penalty points it is not possible to correct a false impulse.

Pre-adjustment of the options:

- | | |
|-----------|--|
| dF-1.0 | finish-delay time = 1.0 seconds |
| dS-9.9 | start-delay time = 9.9 seconds |
| LZE = EIN | running tenth seconds are on |
| LF CH1-2 | running time for display board interface is on channel 1 and 2 |
| TAU AUS | precision is 1/100 seconds |
| HUN Ein | precision is 1/100 seconds |
| Pri 6.0 | printer speed for Printer P3 |

Printer P4: example of a print output:

BAREME A ET C		
TMPL1	055 sec.	maximum allowed time for the 1st round
TMPL2	037 sec.	maximum allowed time for the 2nd round
CD	60 sec.	countdown-time

1st round		
CD	15 sec.	start 15 seconds before the countdown ends
TN	54.67	clear round time of the first round
PP TM	*00.00*	no penalty seconds for time violation
PP	*00.00*	no points for obstacle drop

2nd round (jump off)		
PS	3 sec.	6 penalty seconds from time-out
TO	17.46	Time-out after 17.46 seconds
PS	6 sec.	6 penalty seconds at time-out
TN	38.97	clear round time (including 6 penalty seconds)
PS TM	2 sec	penalty points for time violation during jump off

TT	43.97	total time (clear round time with penalty seconds)
=====		

Display Board GAZc:

It is possible to show the time and penalty points on two display boards (connection drawing see point 2.2). The display board that shows the time must be set on "min - sec - 1/100", the display board that shows the points on "no. - rank".

The interface "display board"(19) is adjusted that it outputs on both channels the running time.

Computer output through RS 232 interface:

The interface from the Timer S4 to a computer is the outlet RS232 (15).

Transfer format: 4800 baud, 1 start bit, 8 ASCII-bit, no parity-bit, 1 stop bit

Data format: ####xTNxxHH:MM:SS.zht(CR)

####xPPxx00:00:0p.000(CR)

####xPSxx00:00:0s.000(CR)

continuous ID number (4-digits)

TN identification for clear round time

PP identification for penalty points

PS identification for penalty seconds

HH:MM:SS.zht time in hours, minutes, seconds and thousandths

p penalty points

s penalty seconds

x blank

(CR) carriage return

3.1.10. Dog - Agility

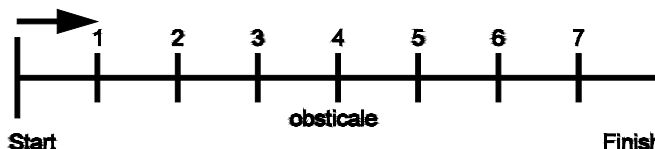

Choose the program:

- press toggle switch (8) upwards (position "program+line test")
- turn device on (switch 17)
- release toggle switch (8)
- select program 2 with yellow button (7)
- if the display (1) shows "Pr.2" and the version number, press the red and yellow button (6+7) together
- press yellow button (7) as many times until it shows in display (1) "Pru."
- press toggle switch (8) down (position "delay time")
- it prints "HUNDESPORT PFRUEFUNG" on the printer, the display (1) shows "LI 00"

Frequency of the horn:

- it is possible to adjust two frequencies for the horn
- normally the horn uses a frequency of 800 Hz
- if you want to use the low frequency put the toggle switch (5) down (position "C-timer") before you set the allowed time
- Set the toggle switch 5 back to position "A-timer"

Input the allowed time:

- input the maximum allowed time (display (1) shows "L1 00")
 - o increase 10 seconds with red button (6)
 - o increase 1 second with the yellow button (7)
- store allowed time by pressing toggle switch (8) down (position "delay time")

Input the maximum time:

- input the maximum time (display (1) shows "L2 00")
 - o increase 10 seconds with red button (6)
 - o increase 1 second with the yellow button (7)
- store maximum time by pressing toggle switch (8) down (position "delay time")

Start:

- set toggle switch (5) on position "A-timer"
- Timer S4 receives a start impulse from the start photocell)
- display (1) shows the running time

Time-out for set up of obstacle:

- press red button (6) or time-out handswitch
- speaker honks at the beginning of the time-out
- press red button (6) or time-out handswitch to finish the time-out period
- speaker honks at the end of the time-out
- the display (1) shows now the penalty seconds and the running time

Penalty points for obstacle drop (5 points):

- push toggle switch to position "B-timer"
- input penalty points with yellow button (7) (you can choose between 0 and 5 points)
- push toggle switch to position "A-timer"

Penalty points (input from 1 to 8 points):

- push toggle switch to position "C-timer"
- input penalty points with yellow button (7) (you can choose from 1 to 8, or 0 points)
- push toggle switch to position "A-timer"

Timing of the clear round time:

- wait until you receive the stop impulse of the finish photocell
- clear round time is shown in display (1) (toggle switch (5) needs to be on position "A-timer"
- The total result (total time, penalty points from penalty time, total penalty points) is printed automatically
- display (1) shows the total time when toggle switch (5) is on position "A-timer" and the total points when toggle switch (5) is on position "B-timer"

Reset of the clock:

- press the yellow button (7) and hold it down
- press the red button (6) and then release both buttons

Attention: You need to have the toggle switch (5) on position "A-timer" during the start, because it won't take the start impulse when you are on another switch position.

Suppression and correction of false impulses:

- ten seconds after the start and during the time-out the system takes no finish impulses
- if you receive a false finish impulse press the yellow button (6), the time runs again

Pre-adjustment of the options:

- dF-1.0 finish-delay time = 1.0 seconds
- dS-9.9 start-delay time = 9.9 seconds
- LZE = EIN running tenth seconds are on
- LF CH1-2 running time for display board interface is on channel 1 and 2
- TAU AUS precision is 1/100 seconds
- HUN Ein precision is 1/100 seconds
- Pri 6.0 printer speed for Printer P3

Printer P4:

HUNDESPORT		
PRUEFUNG		
TMPL1	045 sec.	allowed time
TMPL2	055 sec.	maximum time

PP	5.0	5 penalty points for obstacle drop
TO	25.83	Time-out after 25.83 seconds
PP	5.0	5 penalty points for obstacle drop
LZ	47.35	clear round time (without penalty seconds)
PP TM	*02.35*	penalty points for the clear round time
TT	*12.35*	total penalty points (clear round time and obstacle drop)
=====		

Display Board GAZc:

It is possible to show the time and penalty points on two display boards (connection drawing see point 2.2). The display board that shows the time must be set on "min - sec - 1/100", the display board that shows the points on "no. - rank".

The interface "display board"(19) is adjusted that it outputs on both channels the running time.

Computer output through RS 232 interface:

Transfer format: 4800 baud, 1 start bit, 8 ASCII-bit, no parity-bit, 1 stop bit

Data format: ####xTNxxHH:MM:SS.zht(CR)

####xPPxx00:00:0p.000(CR)

continuous ID number (4-digits)

TN identification for clear round time

PP identification for penalty points

HH:MM:SS.zht time in hours, minutes, seconds and thousandths

p penalty points

x blank

(CR) carriage return

9.1.11. Dog - Agility Gambler**Choose the program:**

- press toggle switch (8) upwards (position "program+line test")
- turn device on (switch 17)
- release toggle switch (8)
- select program 2 with yellow button (7)
- if the display (1) shows "Pr.2" and the version number, press the red and yellow button (6+7) together
- press yellow button (7) as many times until it shows in display (1) "SPi."
- press toggle switch (8) down (position "delay time")
- it prints "HUNDESPORT GAMBLER" on the printer, the display (1) shows "LI 00"

Frequency of the horn:

- it is possible to adjust two frequencies for the horn
- normally the horn uses a frequency of 800 Hz
- if you want to use the low frequency put the toggle switch (5) down (position "C-timer") before you set the allowed time
- Set the toggle switch 5 back to position "A-timer"

Input the allowed time:

- input the maximum allowed time (display (1) shows "L1 00")
 - o increase 10 seconds with red button (6)
 - o increase 1 second with the yellow button (7)
- store allowed time by pressing toggle switch (8) down (position "delay time")

Start:

- set toggle switch (5) on position "A-timer"
- Timer S4 receives a start impulse from the start photocell
- display (1) shows the running time

Time-out for set up of obstacle:

- press red button (6) or time-out handswitch
- speaker honks at the beginning of the time-out
- press red button (6) or time-out handswitch to finish the time-out period
- speaker honks at the end of the time-out
- the display (1) shows now the penalty seconds and the running time

Timing of the clear round time:

- wait until you receive the stop impulse of the finish photocell
- clear round time is shown in display (1) (toggle switch (5) needs to be on position "A-timer")
- The total result (total time, penalty points from penalty time, total penalty points) is printed automatically
- if the allowed clear round time is reached it honks

Reset of the clock:

- press the yellow button (7) and hold it down
- press the red button (6) and then release both buttons

Suppression and correction of false impulses:

- ten seconds after the start and during the time-out the system takes no finish impulses
- if you receive a false finish impulse press the yellow button (6), the time runs again

Pre-adjustment of the options:

dF-1.0 finish-delay time = 1.0 seconds
 dS-9.9 start-delay time = 9.9 seconds
 LZE = EIN running tenth seconds are on
 LF CH1-2 running time for display board interface is on channel 1 and 2
 TAU AUS precision is 1/100 seconds
 HUN Ein precision is 1/100 seconds
 Pri 6.0 printer speed for Printer P3

Printer P4:

HUNDESPORT	
GAMBLER	
TMPL	045 sec.

TO	25.83
PS	0 sec.
LZ	42.35
=====	

allowed time

Time-out after 25.83 seconds

input of time-out penalty seconds is not possible

clear round time (without penalty seconds)

Display Board GAZc:

It is possible to show the time and penalty points on two display boards (connection drawing see point 2.2). The display board that shows the time must be set on "min - sec - 1/100", the display board that shows the points on "no. - rank".

The interface "display board"(19) is adjusted that it outputs on both channels the running time.

Computer output through RS 232 interface:

Transfer format: 4800 baud, 1 start bit, 8 ASCII-bit, no parity-bit, 1 stop bit

Data format: #####xTNxxHH:MM:SS.zht(CR)

#####xPSxx00:00:00.000(CR)

continuous ID number (4-digits)

TN identification for clear round time

PS identification for penalty seconds (always 0)

HH:MM:SS.zht time in hours, minutes, seconds and thousandths

p penalty points

x blank

(CR) carriage return

4. DEVICES USED WITH THE TIMER S4

4.1. Printer P4

Electrosensitive printer that connects to the Timer S4 (socket "printer 16").
The Printer P4 is powered by the Timer S4.

Attention: you must use NiCad batteries in the Timer S4.

o Paper Check:

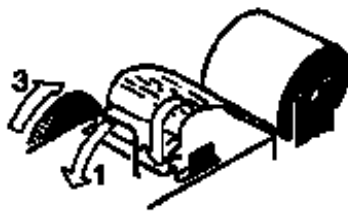

- Push the two cover release buttons down so that they jump up. Remove the cover.
- If you have enough paper, put the cover back and the two buttons down until they stay in the position.

Attention: Make sure that the paper comes out through the slotted hole in the cover! Make sure the paper bow spring is folded back.

o Changing the paper:

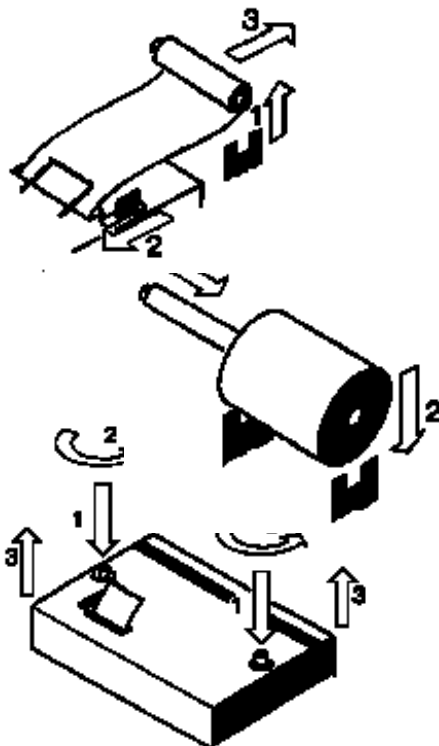

- Remove the rest of the paper from the holder.
- Press the black lever forward and pull the paper out.
- Put the axle into the new paper roll.
- Put the new roll on the paper holder.
- Move paperbow spring into the backward position.
- Insert the beginning of the paper into the paper feed of the printer. Make sure it is cleanly cut.
- Turn the paper advance wheel towards the rear until paper comes out.
- If necessary correct the paper path through pressing the black lever forward and adjusting the paper manually.
- Put the cover back and press the two buttons until stay in the lower position.

Clearing Jammed Paper:

- Press the black lever forward and pull back the remaining paper.
- Remove the serrated cutter by holding the black lever forward and sliding the cutter towards the lever and lifting upwards.
- Pull the printhead back with your fingernail and remove any stuck paper with tweezers or small needlenose pliers.
- If the paper has jammed under the roller it will be necessary to remove it by sliding a piece of 35mm film through the paper path and rocking it to and fro until the stuck paper is expelled. Use a piece of film about 20 cm long to have something to hold onto.

The printer is a very rugged device but needs regular maintenance for a long service life. Call your ALGE agent if you have further questions.

Printer-Paper:

Electrosensitive paper 60 mm width, 40 mm diameter with about 25 m paper length (about 6000 lines). The electrosensitive paper is available at your ALGE representative.

A black strip will become visible on the edge of paper, when a paper roll is about to run out.

Attention: Do not pull on the paper when printing. Press the black lever forward and pull the paper carefully out, if the paper is repressed.

The printer-paper has to stay dry!

5. TECHNICAL DATA

Measuring range: 23 hours, 59 minutes, 59.999 seconds, for Program 2 it is 999,999 sec.

Crystal frequency: TCXO 9.216 MHz (Temperature compensated Crystal Oscillator)

Accuracy:

at changeable temperature: +/- 2,5 ppm at -30 to +75°C (+/-0,009 sec/h)
Aging: +/- 1 ppm per year
Frequency adjustment: +/- 0,2 ppm at +25°C

Operative timing range: -25 to 50°C

Memory: 8000 times with continuous ID number;
memory is unaffected when device is turned off due to built in batteries.

Display: Liquid Crystal Display, 8 digits, figure height 12,7 mm

Electronic: the most advanced CMOS technology

Power consumption: without external devices, from internal battery: about 60 mA per hour
without external devices.

Impulse channels: input resistance 10 kW / +5V
triggering with < 1V (falling flank)
hysteresis about 2 V

Output 5VDC stabilized: total max of 120 mA

Speech Amplifier: communication through channel C0, C1, C2, C3, C6, and C9

Loud Speaker: for 8 W loud speaker, $U_{max} = 24 V_{pp}$

Operating elements:

1	on/off switch	(17)
1	red button "start/stop"	(6)
1	yellow button "next"	(7)
1	toggle switch "A-, B- and, C-timer"	(5)
1	toggle switch "program+line test, delay time"	(8)

Casing: anodized aluminium case
L x W x H = 226 x 162 x 95

Weight: 2.2 kg (with batteries)

5.1. Connection System

5.1.1. Photocell jacks and external supply

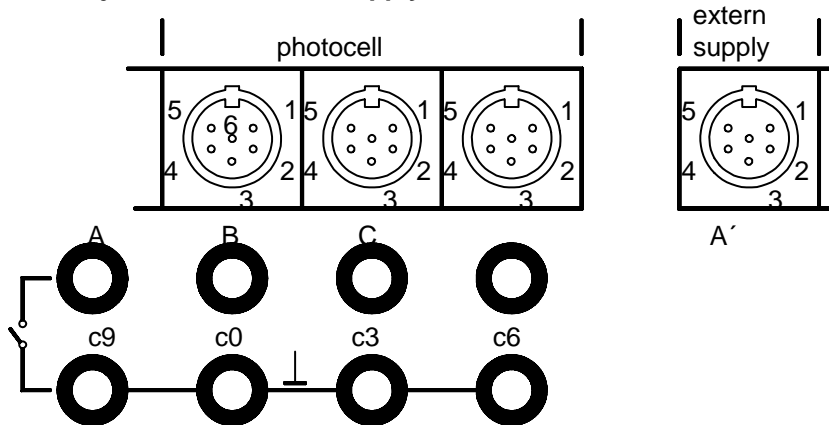

Jack A and A' (10 and 13):

- 1 input channel 0 (start)
- 2 input channel 1 (stop)
- 3 common ground
- 4 input external supply (6 to 15 Volt)
- 5 output +5 VDC stabilized
- 6 input channel 2 (intermediate time)

Jack B (11):

- 1 input channel 3 (start)
- 2 input channel 4 (stop)
- 3 common ground
- 4 input external supply (6 to 15 Volt)
- 5 output +5 VDC stabilized
- 6 input channel 5 (intermediate time)

Jack C (12):

- 1 input channel 6 (start)
- 2 input channel 7 (stop)
- 3 common ground
- 4 input external supply (6 to 15 Volt)
- 5 output +5 VDC stabilized
- 6 input channel 8 (intermediate time)

5.1.2. Headset Jack Q34 (9)

- 1 microphone of headset
- 2 common ground
- 3 loud speaker of headset
- 4 common ground
- 5 channel 9

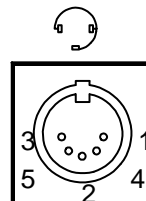

5.1.3. Loud Speaker Jack (24)

- 1 speaker signal
- 2 common ground

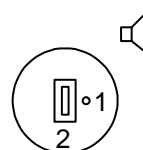

5.1.4. Display Board Jack (14)

- 1 common ground
- 2 output supply (6 to 15 VDC)
- 3 output data channel 1
- 4 output supply (6 to 15 VDC)
- 5 output data channel 2

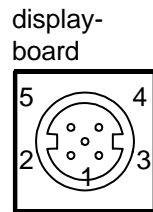

5.1.5. Printer Jack (16)

- 1 common ground
- 2 output supply (6 to 15 VDC)
- 3 output data channel 1
- 4 output supply (6 to 15 VDC)
- 5 output data channel 2

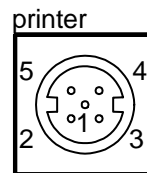

5.1.6. RS 232c - Computer Jack (15)

- 1 data TXD
- 2 common ground
- 3 data RXD
- 4 CTS
- 5 RTS
- 6 empty
- 7 output external supply (6 to 15 VDC)
- 8 empty

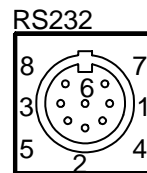

5.1.7. Multi Channel Outlet (22)

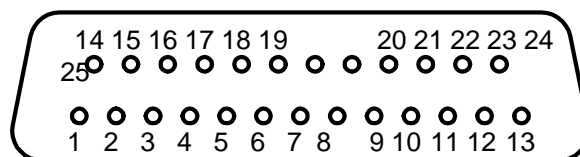

- | | |
|-----------------------|---|
| 1 channel 9 | 13 output +5 VDC stabilized |
| 2 channel 0 (start) | 14 channel 1 |
| 3 channel 2 | 15 channel 5 |
| 4 channel 3 | 16 channel 8 |
| 5 channel 7 | 17 channel 6 |
| 6 output data | 18 channel 4 |
| 7 channel 10 (I/O 0) | 19 channel 11 (I/O 1) |
| 8 channel 12 (I/O 2) | 20 channel 13 (I/O 3) |
| 9 channel 15 (I/O 5) | 21 channel 16 (I/O 6) |
| 10 channel 17 (I/O 7) | 22 channel 14 (I/O 4) |
| 11 output data | 23 output external supply (5,3 to 14,3 VDC) |
| 12 common ground | 24 common ground |
| | 25 external supply (6 to 15 VDC) |

5.2. Computer connection - RS 232c interface (15)

Transfer format: 1 start bit, 8 ASCII bit, no parity bit, 1 stop bit
 Transfer speed: pre adjustment 4800 Baud
 Pin arrangement of jack: seepoint 5.1.7.

You can send control codes form a PC through the RS 232 interface to the Timer S4. You have to send the control codes and finish them with carriage return.

Control Code	Interface	Effect
80(Hex)	Display Board (14), Display (1)	1/10 second on or off of the running time
81(Hex)	Display Board (14), Printer (16), and Display (1)	1/1000 seconds on or off (precision)
82(Hex)	Start delay time	input start delay time (in ASCII, two figures; sec, 1/10)
83(Hex)	Finish delay time	input finish delay time (in ASCII, two figures; sce, 1/10)
84(Hex)	RS232 (15)	output of memory blocks (in ASCII, 2 x 4 figures)
85(Hex)	RS232 (15)	output of memory
86(Hex)	Display (1)	1/1000 seconds shown on display (1)
87(Hex)	Prog.3 special	special adjustment for program 3 (see page 59)
88(Hex)	RS232 (15)	9600 Baud
89(Hex)	RS232 (15)	4800 Baud
8A(Hex)	RS232 (15)	2400 Baud
8B(Hex)	RS232 (15)	1200 Baud
8C(Hex)	Display Board (14)	net time on or off (only for program 3 with net time)
8D(Hex)	Display Board (14)	19200 Baud
8E(Hex)	Display Board (14)	9600 Baud
8F(Hex)	Display Board (14)	4800 Baud
90(Hex)	Display Board (14)	2400 Baud
91(Hex)	Display Board (14), Printer (16), and Display (1)	1/100 seconds on or off (precision)
92(Hex)	RS232 (15)	amount of LINE FEED from 0 to 9 (in ASCII)
93(Hex)	Finish delay time	finish delay time in 1/100 seconds or or off
94(Hex)	RS232 (15)	output in one string on or off
95(Hex)	Memory (RAM)	clear memory
96(Hex)	Printer (16)	19200 Baud
97(Hex)	Printer (16)	9600 Baud
98(Hex)	Printer (16)	4800 Baud
99(Hex)	Printer (16)	2400 Baud
9A(Hex)	Display Board (14)	output on interface "display board" (14) evey 1/10 or second

Data cable from Timer S4 to PC (IBM compatible):

- o PC with 9 pin interface: cable 067-02
- o PC with 25 pin interface: cable 066-03

Memory:

Memory output:

85(Hex)

All times which are stored in the memory (RAM) of the Timer S4 will be transferred (e.g. to a computer) using the RS 232 interface (15) by input of hexadecimal code 85.

85 (Hex) output of memory on RS 232 interface (15)

Memory output in blocks:

84(Hex)

It is possible to output a block of data from the memory (RAM) of the Timer S4 using the RS 232 interface (15). You have to input the hexadecimal code 84, the first address and the last address in ASCII.

e.g.: 84(Hex)09341330 = output of all data from memory number 934 to 1330 through the RS 232 interface

84 (Hex) output of memory blocks on the RS 232 interface (15)

Clear memory:

95(Hex)

Input of hexadecimal 95 clears the memory (RAM). The memory can store up to 8000 times

95(Hex) clear memory

Adjustment of Precision:

You can adjust a precision of 1/10, 1/100, or 1/1000 seconds. The precision is used for the display (1), display board (14), and printer (16). The RS 232 output (15) uses always 1/1000 seconds.

81(Hex) 1/1000 seconds on or off

91(Hex) 1/100 seconds on or off

1/10 mode: 1/1000 off 1/100 off

1/100 Mode: 1/1000 off 1/100 on

1/1000 Mode: 1/1000 on 1/100 on

If you want to see the 1/1000 seconds on the display (1), you have to move the format two characters to the left by input of hexadecimal code 86. Now the display shows minutes, seconds and thousandths.

86(Hex) switches 1/1000 second on display (1) on or off

Adjustment of delay time:

You can adjust the delay time by sending the hexadecimal code 82 or 82 and then two digits for the delay time (ASCII-code). The first digit is seconds, the second digit tenth.

82(Hex) input of start-delay time

83(Hex) input of finish-delay time

With the hexadecimal code 93 you can switch from seconds and tenth to tenth and hundredths.

93(Hex) change finish-delay time from tenth to hundredths mode

RS 232c interface (15):**Baud rate adjustment:**

You can change the baud rate of the RS 232 interface (15) by input of a hexadecimal code. In order to change the baud rate you have to use the actual baud rate.

88(Hex) 9600 baud

89(Hex) 4800 baud

8A(Hex) 2400 baud

8B(Hex) 1200 baud

Pre-adjusted baud rate is: 4800

Transmission in one or two strings:**94(Hex)**

When working in program "18-Channel-Timer with time of day" a you can adjust if the time of day and net time is transmitted to the interface "display board" (14) in one or two strings. Pre-adjustment is two strings.

94(Hex) transmission in one or two strings for interface "display board" (14)

Memory output:**85(Hex)**

All times which are stored in the memory (RAM) of the Timer S4 will be transferred (e.g. to a computer) using the RS 232 interface (15) by input of hexadecimal code 85.

85 (Hex) output of memory on RS 232 interface (15)

Memory output in blocks:**84(Hex)**

It is possible to output a block of data from the memory (RAM) of the Timer S4 using the RS 232 interface (15). You have to input the hexadecimal code 84, the first address and the last address in ASCII.

e.g.: 84(Hex)09341330 = output of all data from memory number 934 to 1330
through the RS 232 interface

84 (Hex) output of memory blocks on the RS 232 interface (15)

LINE FEED for RS 232 interface (15):**92(Hex)**

You can adjust the amount of LINE FEED for the RS232c interface. Adjustment from 0 to 9 line feed is possible. Input first the hexadecimal code 92 and the amount of line feed in ASCII.

92(Hex) amount of LINE FEED from 0 to 9 (in ASCII)

"Display Board" interface (14):

Change baud rate of Display Board interface (14):

You can change the baud rate of the display board interface (14) by input of a hexadecimal code.

- 8D(Hex)** 19200 baud
- 8E(Hex)** 9800 baud
- 8F(Hex)** 4800 baud
- 90(Hex)** 2400 baud

Pre-adjusted baud rate is: 2400

Display net time on display board:

8C(Hex)

You can use the 18-Channel-Timer with time of day. Using time of day there are the following possibilities to transfer the data on the interface "display board" (15).

- channel 1 = running time
- channel 2 = finish time

Channel	Switch (5)	usual adjustment	with code 8C(Hex)
channel 1	A-timer	time of day, 2400 baud	time of day + net time, 4800 baud
channel 1	B-timer	time of day, 2400 baud	time of day + net time, 4800 baud
channel 1	C-timer	net time, 2400 baud	time of day + net time, 4800 baud
channel 2	A-timer	net time, 2400 baud	net time, 4800 baud
channel 2	B-timer	net time, 2400 baud	net time, 4800 baud
channel 2	C-timer	net time, 2400 baud	net time, 4800 baud

Using hexadecimal code 8C to change to time of day and net time, it changes the baud rate automatically from 2400 to 4800 baud. A baud rate of 2400 is for this mode not possible.

Output of running tenth:

80(Hex)

If you want to have the tenth seconds of the running time on the interface "display board" (14) input hexadecimal code 80. If the running tenth is active it shows also the running tenth on the display (1). If you input 80(Hex) again, it turns the running tenth off.

80(Hex) display tenth second of running time

Second mode or 1/10 mode:

9A(Hex)

The "display board" interface has in the running time mode (output channel 1) an output every 1/10 second. If you want an output every second input the hexadecimal code 9A. In order to return to the 1/10 mode input again 9A(Hex).

Printer Interface (16):

Change baud rate of Printer interface (16):

You can change the baud rate of the printer interface (14) by input of a hexadecimal code.

- 96(Hex)** 19200 baud
- 97(Hex)** 9800 baud
- 98(Hex)** 4800 baud
- 99(Hex)** 2400 baud

Pre-adjusted baud rate is: 2400

Display (1):

Output of running tenth: **80(Hex)**

If you want to have the tenth seconds of the running time on the interface "display board" (14) input hexadecimal code 80. If the running tenth is active it shows also the running tenth on the display (1). If you input 80(Hex) again, it turns the running tenth off.

80(Hex) display tenth second of running time

Prog. 3 special:

87(Hex)

This mode is only effective in program 3.

With the hexadecimal code 87 you adjust the following:

- | | |
|--------------|---|
| dF-0.2 | finish delay time = 0.2 seconds |
| dS-1.0 | start delay time = 1 second |
| SLP 5.0 | duration of displaying on display and display board = 5 seconds |
| TO nod | Time-out mode |
| nET EIn | interface "display board" (14) transfers time of day and net time |
| LZE EIn | running 1/10 seconds are off |
| TAU EIn | precision is 1/1000 seconds |
| HUn AUS | precision is 1/1000 seconds |
| AUT EIn | display automatic is on |
| Pri 0.0 | printer output for printer with buffer |
| Line feed: 5 | Line feed |
| Printer: | 4800 Baud |
| RS232c: | output in one line without identification |

e.g.: ####xHH:MM:SS.zhtxHH:MM:SS.zht(CR)(LF)(LF)(LF)(LF)

- | | |
|--------------|---|
| #### | continuous ID number (4 digits) |
| HH:MM:SS.zht | time in hours, minutes, seconds, and 1/1000 seconds |
| x | blank |
| (CR) | carriage return |
| (LF) | line feed |

5.3. Connection for the display board

Connect cable 010-10 at the Timer S4 (socket "display board" (14) and at the banana sockets of the display board.

Transfer format: 1 start bit, 8 ASCII bit, no parity bit, 1 stop bit
Transfer speed: 2400 baud
Pin connection: see page 56

Data cable from Timer S4 to display board GAZc:

- o cable 010-10
- o extension with cable reel KT 300 or KT 500

Attention: You can turn the plug of cable (010-10) 180°. By turning the plug you switch between channel 1 and channel 2. It depends on the program you use and the adjustment of the options if you have different data on the two channels.

5.4. Connection for Printer P4 (16)

Plug the cable of the Printer P4 at the Timer S4 (socket "printer" (16).

Transfer format: 1 start bit, 8 ASCII bit, no parity bit, 1 stop bit
Transfer speed: 2400 baud
Pin connection: see point 5.1.5.